

EVO 6000 Series

Ultra Compact Vector Drive

USER MANUAL



Table of Contents

1.1 General Safety.....	5
1.1.1 Usage.....	5
1.1.2 Receiving	5
1.1.3 Installation.....	5
1.1.4 Wiring.....	5
1.1.5 Operation	6
1.1.6 Maintenance	7
1.2 Warning Label.....	7
1.3 AC Drive Application Precautions	8
1.3.1 AC Drive Selection	8
1.3.2 Settings	9
1.3.3 General Handling.....	9
1.4 Warranty.....	10
1.4.1 Warranty Period	10
1.4.2 Warranty Restrictions	10
Chapter 2 Product	11
2.1 Component Names	11
2.3 Nameplate.....	12
2.4 Model Number Definition	12
2.5 Power Ratings.....	13
2.6 Common Specifications	14
2.7 Product Dimensions.....	16
Chapter 3 Drive Installation.....	17
3.1 Installation Environment	17
3.2 Installation Direction and Spacing.....	18
3.2.1 Installation Direction.....	18
3.2.2 Installation Spacing	18
3.3 Keypad and Terminal Cover Installation	19
3.4 Wiring Protection.....	20
3.4.1 Drive and Input Cable Protection for Short-Circuit Situations.....	20
3.4.2 Motors and Output Cable Protection for Short-Circuit Situations	20
Chapter 4 Wiring.....	21
4.1 Wiring Safety.....	21
4.2.1 Main Circuit Terminal.....	23
4.2.2 Main Circuit Wiring	23
4.2.3 Main Circuit Cable Size and Tightening Torque	25
4.3 Control Circuit.....	27

4.3.1 Control Circuit Terminals	28
4.3.2 Control Circuit Wiring	29
4.3.3 Control Circuit Cable Size and Tightening Torque.....	29
4.3.4 Ferrule-Type Terminals.....	30
4.4.1 NPN and PNP Mode Selection	31
4.5 Wiring Checklist	33
Chapter 5 Keypad	34
5.1 Check before Operation.....	34
5.2 Powering Up the Drive and Operation Status Display	34
5.3 Keypad.....	35
5.3.1 Keys and Displays	35
5.3.2 Keypad Display.....	37
5.3.3 Keypad Programming.....	39
Chapter 6 Parameters	40
6.1 Parameter	40
6.1 Group A, Initialization	40
6.2 Group b, Application.....	45
6.3 Group C, Tuning	70
6.4 Group L, Frequency Command.....	77
6.5 Group d, Motor Parameters	88
6.6 Group E, Multi-Function Terminals	95
6.7 Group P, Protections.....	124
6.8 Group o, Keypad Function Settings.....	141
6.9 Group t, Auto-Tuning.....	145
t1 IM Motor Auto-Tuning.....	145
6.10 Group U, Monitor Settings	148
Chapter 7 Options.....	153
7.1 AC Reactor Option.....	153
7.1.1 Installing an AC Reactor	153
7.1.2 AC Reactor Wiring Example	153
7.2 Installing Input Fuses	154
Chapter 8 Troubleshooting	155
8.1 Alarm and Fault Displays.....	155
8.2 Fault Detection	159
8.3 Operation Errors.....	167
8.4 Auto-Tuning Fault Detection (Under Development)	169
Chapter 9 Inspection & Maintenance.....	170
9.1 Safety	170
9.2 Periodic Inspection.....	171

9.2.1 Environment.....	171
9.2.2 Voltage.....	171
9.2.3 Keypad Monitor	171
9.2.4 Enclosure	171
9.2.5 Main Circuit.....	172
9.2.6 Main Circuit- Terminals & Cables.....	172
9.2.7 Main Circuit- Capacitors.....	172
9.2.8 Main Circuit- Resistors.....	173
9.2.9 Main Circuit- Magnetic Contactors & Relays	173
9.2.10 Control Circuit- Control Boards & Connectors	173
9.2.11 Cooling- Fans	174
9.2.12 Cooling- Air Duct.....	174
9.3 Drive Cooling Fans.....	174
9.3.1 Cooling Fan Replacement.....	174
9.3.2 Removing Cooling Fan	175
Chapter 10 Drive Derating.....	176
10.1 Temperature Derating	176
10.2 Altitude Derating	176
Chapter 11 Communications.....	177
11.1 Modbus Communication Specifications.....	177
11.2 Connecting to Controller/PLC/HMI.....	177
11.2.1 Communication Cable Connection.....	177
11.3 Modbus Setup Parameters.....	178
11.4 Drive Operations by Modbus	179
11.4.1 Actions by Modbus.....	179
11.4.2 Drive Control by Modbus.....	179
11.5 Message Format	180
11.5.1 Message Content	180
11.5.2 Message Configuration.....	180
11.5.3 Slave Station Address.....	180
11.5.4 Function Code.....	180
11.5.5 Data	180
11.5.6 Error Check.....	181
11.5.7 Command Data.....	181
11.5.8 Response Message	182
11.6 Example of Reading / Responding Data.....	182
11.7 Modbus Data.....	184
11.8 Communication Errors	188
11.8.1 Modbus Errors.....	188
11.8.2 Slave Response	189

Chapter 1 | Safety

1.1 General Safety

Safety Information:

Warning: Indicates highly dangerous consequences such as fire, serious injury and death when failing to comply with the instructions.

Caution: Indicates dangerous consequences such as moderate injury and equipment damage when failing to comply with the instructions.

1.1.1 Usage

Danger
<ol style="list-style-type: none">1. The drive is used to control the speed of 3 phase synchronous and asynchronous motors, which must not be used for single phase or other purposes. Failure to comply could cause drive damage or serious injury by fire.2. The drive must not be used in any medical equipment in which human life may involve.3. The drive is manufactured according to strict quality control standard. However, bypass the safety protection in case the drive failure causes death or serious injury.

1.1.2 Receiving

Warning
<ol style="list-style-type: none">1. Do not install damaged drive or any drive without complete components inside. Failure to comply could result in accident.

1.1.3 Installation

Warning
<ol style="list-style-type: none">1. Carry the drive by the bottom as carrying by the front cover may cause injury and damage from the main body of the drive falling.2. Attach the drive to metal or other nonflammable materials. Keep away from heat and flammable items.3. A control panel must have cooling fans, air vents and room for ventilation when the drive is installed inside.

1.1.4 Wiring

Danger

1. Allow only qualified electrical engineers to install the drive. Failure to comply could cause electrical shocks to personnel or damage to the drive.
2. Ensure the power supply is off when connecting. Failure to comply could cause electrical shocks.
3. Ensure the ground terminal PE is properly wired. Failure to comply could cause electrical shocks from the drive cover. Therefore ground the drive and motor for personnel safety.
4. Do not touch the main circuit terminal. Keep the main circuit off drive cover to avoid electrical shocks.
5. The terminal for braking unit is + and -. Do not connect it to any other terminals. Failure to comply could cause a fire.

Warning

1. Do not connect three-phase power supply to terminals U, V and W. Failure to comply could damage the drive.
2. An output reactor is recommended when the cable connecting between the drive and motor is over 100 meters. Failure to comply could result in drive damage with overcurrent caused by over-distributed capacitance.
3. Never connect the output terminals to capacitors or unapproved LC/RC filters. Failure to comply could damage the drive components.
4. Separate the drive main circuit cables and control circuit cables. Failure to comply could cause interference to the control signals
5. Ensure the phase of power supply and rated voltage match the label on the drive. Failure to comply could drive damage.

1.1.5 Operation

Danger

1. Connect the power after completion of wiring and closing the front cover. Opening the front cover when the power is on could cause an electrical shock.
2. Keep other personnel off the equipment when setting the drive fault restart and momentary power loss restart functions. Failure to comply could cause damage to the personnel and equipment.
3. Once the drive is powered, the terminals are live even when drive is not in operation. Touching the terminals could cause electrical shocks.
4. Cancel run command before resetting the alarm and fault. Failure to comply could cause physical injury.

Warning

1. Do not start or stop the drive by connection or disconnection the power supply. Failure to comply could cause drive damage.
2. Ensure the motor and equipment are in proper use before operation. Failure to; comply could damage the equipment.
3. The temperature of the braking resistor and heatsink could be very high during operation. Do not touch it or it could result in scald.
4. For lift applications, please install mechanical brakes.
5. Adjust a few parameters only if necessary as the defaults are optimum settings for most of applications. Editing parameters indiscriminately could cause equipment abnormal operation.
6. Interlock the electricity supply with AC drive supply when both are available to a motor.

1.1.6 Maintenance

Danger
<ol style="list-style-type: none"> 1. Do not touch the main circuit of the drive when power is on. Failure to comply could cause electrical shocks. 2. Disconnect the power supply before opening the front cover of the drive. 3. Maintain the drive 5 minutes after turning off power supply, so as to avoid charged capacitors causing physical injury. 4. Allow only qualified electric engineers and electrician to maintain, repair and replace the AC drive modules.
Warning
<ol style="list-style-type: none"> 1. The release of breaker on the AC drive primary side could be caused by incorrect wiring, short circuit and damaged drive components. Investigate and remove the problem before reconnecting the breaker. 2. Do not use a megger (insulation resistor) to test the drive control circuit. Failure to comply could cause drive damage.

Notice:

All the instruction photographs and diagrams of opened drive in this manual are only for illustration. Do not attempt to operate any AC drives with the cover opened.

1.2 Warning Label

The warning label is on the front of the drive. Please read it carefully and follow the instructions.

- Read the user manual before operation.
- Risk of electrical shock. Shut off main power and wait for 5 minutes before servicing.
- Hot surface. Risk of burn.

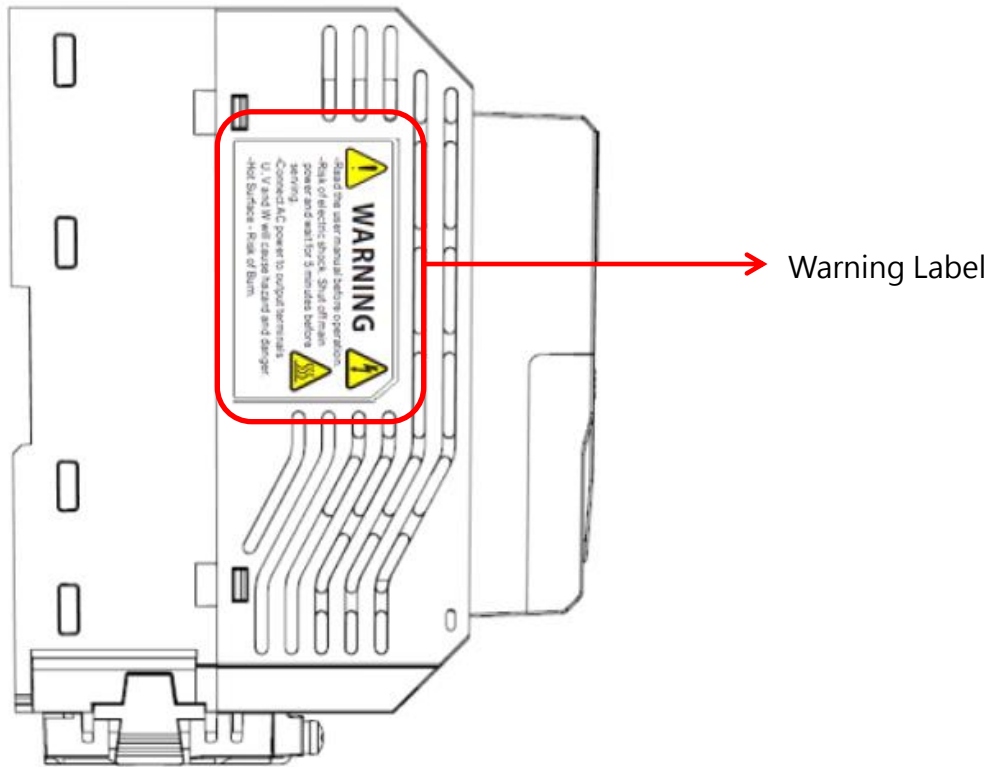

1.3 AC Drive Application Precautions

1.3.1 AC Drive Selection

1.3.1.1 Drive Capacity

Before driving motors, ensure the motor rated current is lower than the drive rated output. In addition, when a single AC drive is driving more than 1 motor in parallel, make sure the drive capacity is higher than 110% of total motor rated current.

1.3.1.2 Starting Torque

The motor characteristics at start and during acceleration are limited by the drive overcurrent. If higher starting torque is needed, use a higher rating drive or increase capacity of both motor and drive.

1.3.1.3 Emergency Stop

When a drive fault occurs, protection function will be automatically triggered to shut off the output but the motor may not stop immediately. Therefore please install mechanical brake if immediate stop is necessary.

1.3.2 Settings

1.3.2.1 Upper Limits

The maximum output frequency of the drive is 400Hz. If the upper limit is set incorrectly, the motor will run at higher than its rated speed and cause danger. Please set the limit of output frequency in Frequency Upper Limit parameter. The default setting of the rated output frequency is 60Hz.

1.3.2.2 DC Braking

Excessive DC braking current and duration could cause motor overheat.

1.3.2.3 Acceleration /Deceleration Time (Acc./Dec. Time)

Acceleration and deceleration time is determined by the motor torque, load torque and load inertia. Set a longer Acc./Dec. time after Stall Prevention function is triggered. In addition, the acceleration and deceleration time will be extended depending on the Stall Prevention duration. If faster acceleration and deceleration are required, install proper braking options or use a higher rating motor and AC drive.

1.3.3 General Handling

1.3.3.1 Wiring

Connecting power supply to output terminals U/T1, V/T2 and W/T3 will damage the drive. Check all the connections and wiring sequence before turning on the power. Failure to comply could cause drive damage.

1.3.3.2 Maintenance

Capacitors in the drive may still be charged for a short time after shutting off the power. Wait for the amount of time specified on the drive before any maintenance. Failure to comply could cause electrical shocks to personnel. Besides, do not touch the heatsink which can be very hot during operation. Replace the cooling fan only when the heatsink has cooled down after shutting off the power. In addition, when a synchronous motor is coasting to stop, it regenerates voltage to keep the drive terminals live even when the drive power is off. Wait until the motor is fully stopped before drive maintenance. Failure to comply could cause electrical shocks to personnel.

1.3.3.3 Wiring Tools

Use only the tools suggested by the terminal supplier during drive maintenance.

1.3.3.4 Transportation and installation

Do not expose the drive to the environment containing the halogens or DOP gas during transportation or installation.

1.4 Warranty

1.4.1 Warranty Period

Contact local distributor for details.

1.4.2 Warranty Restrictions

Warranty is not applicable when the drive is not properly used according to the manual regardless warranty period.

Chapter 2 | Product

2.1 Component Names

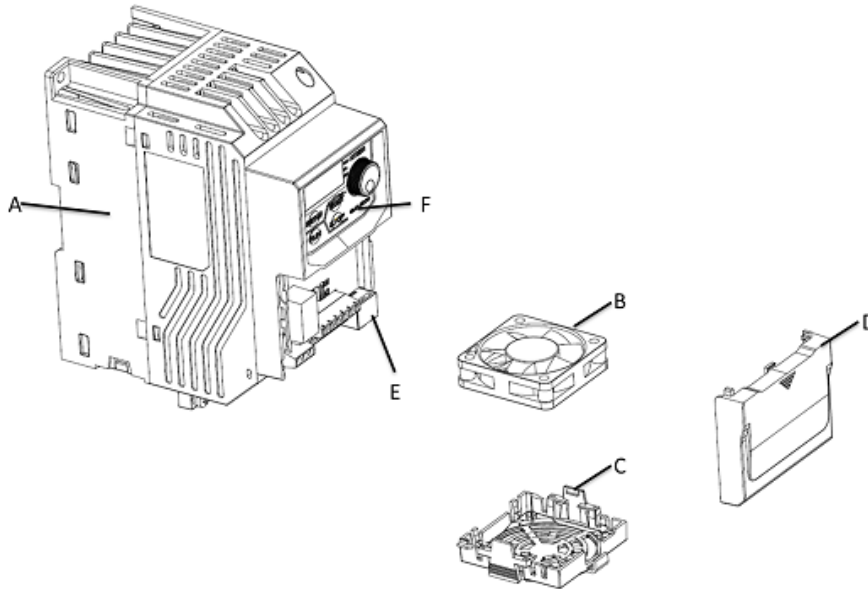

- A – Heatsink
- B – Cooling fan
- C – Fan guard
- D – Conduit bracket
- E – RJ45 port
- F – Keypad

2.2 Receiving Checklist

Check the following when receiving the drive:

1.	Is the packaging box in good condition? Any damage or damp ? If so, contact the distributor or local Lite-On representative.
2.	Is the model label on the box same as what you purchased? If not, contact the distributor or local Lite-On representative.
3.	After opening the box, is there any damp mark inside the box? Any damage or crack on the drive enclosure? If so, contact the distributor or local Lite-On representative.
4.	Does the drive nameplate show the same model number as the carton label? If not, contact the distributor or local Lite-On representative.
5.	Is the manual included in the carton? If not, contact the distributor or local Lite-On representative.

2.3 Nameplate

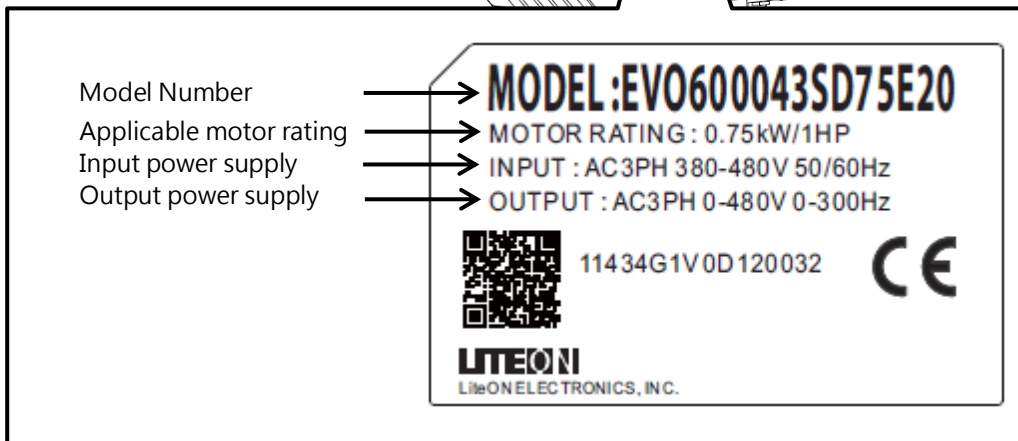
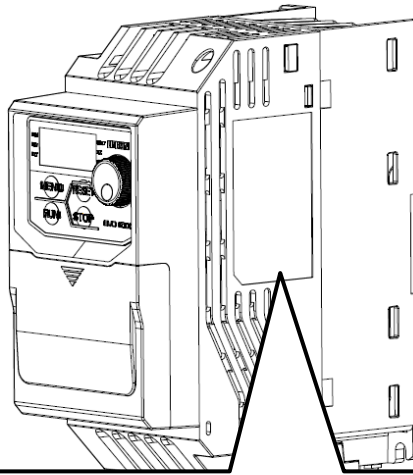

2.4 Model Number Definition

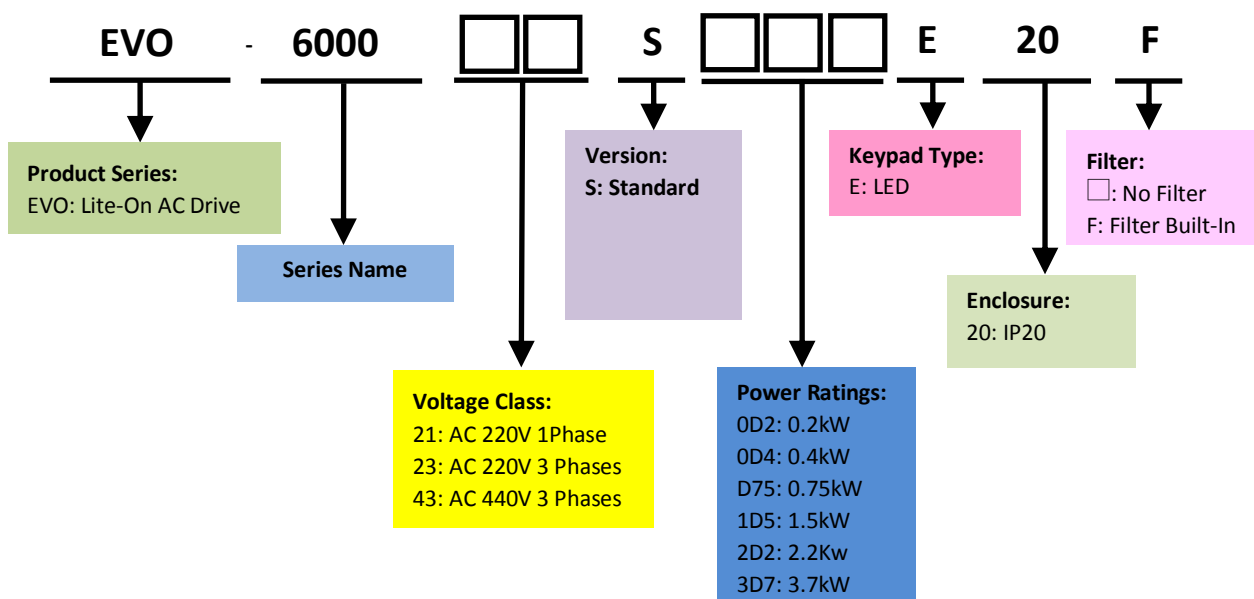

2.5 Power Ratings

200V Class Single Phase						
Model No.	EVO600021S	0D2	0D4	D75	1D5	2D2
Max. Motor Capacity	HP	0.25	0.5	1	2	3
	kW	0.2	0.4	0.75	1.5	2.2
Rated Input	Voltage (V) / Frequency (Hz)	Single Phases, 200 ~240 V, -15% ~ +10% , 50/60Hz				
	Current(A)	3.6	7.4	13.5	24	33
Rated Output	Current(A)	1.6	2.5	4.2	7.5	11
	Output Frequency(Hz)	0 to 400 Hz				
	Carrier Frequency (kHz)	2 to 12kHz				
Cooling Method		Fanless		Fan		
Frame Size		1			2	
Weight		1.1kg			1.6kg	

200V Class Three Phase							
Model No.	EVO600023S	0D2	0D4	D75	1D5	2D2	3D7
Max. Motor Capacity	HP	0.25	0.5	1	2	3	5
	kW	0.2	0.4	0.75	1.5	2.2	3.7
Rated Input	Voltage (V) / Frequency (Hz)	Three Phases, 200 ~240 V, -15% ~ +10% , 50/60Hz					
	Current(A)	2.2	3.7	6.6	10.5	14.8	21.5
Rated output	Current(A)	1.6	2.5	4.2	7.5	11	17
	Output Frequency(Hz)	0 to 400 Hz					
	Carrier Frequency (kHz)	2 to 12kHz					
Cooling Method		Fanless		Fan			
Frame Size		1			2		
Weight		1.1kg			1.6kg		

400V Class Three Phase						
Model No.	EVO600043S	0D4	D75	1D5	2D2	3D7
Max. Motor Capacity	HP	0.5	1	2	3	5
	kW	0.4	0.75	1.5	2.2	3.7
Rated Input	Voltage (V) / Frequency (Hz)	Three Phases, 380 to 480 V, -15% to +10% , 50/60Hz				
	Current(A)	2.7	4.4	6.7	9.3	12.9
Rated Output	Current(A)	1.5	2.5	4.2	5.5	8.2
	Output Frequency(Hz)	0 to 400 Hz				
	Carrier Frequency (kHz)	2 to 12kHz				
Cooling Method		Fanless		Fan		
Frame Size		1			2	
Weight		1.1kg			1.6kg	

2.6 Common Specifications

Item		Specification
Control Characteristic	Control Method	V/F Control, Sensorless Voltage Vector Control (SVVC)
	Output Frequency	0~400 Hz
	Frequency Accuracy	Digital Input: within $\pm 0.01\%$ of the Max. output frequency
		Analog Input: within $\pm 0.1\%$ of max. output frequency(-10°C ~ +50°C)
	Frequency Setting Resolution	Digital input: 0.01Hz
		Analog Output: 1/1000 of max. frequency
	Starting Torque	150% / 3Hz (V/F)
		150% / 1Hz (SVVC)
	Speed Control Range	1: 40 (V/F)
		1: 100 (SVVC)
Acc./Dec. Time	0.0 to 3600.0	
Braking Torque	approx. 20%	
V/F Pattern	15 fixed and 1 programmable	
Overload Capacity	150% for 1 min. within every 10 min.	

	Parameter Function	Overtorque/Undertorque Detection, Multi-Speed Operation, Acc./Dec. Switch, S-Curve Acc./Dec., 3-Wire Sequence Control, Auto-Tuning, Cooling Fan ON/OFF Switch, Slip Compensation, Torque Compensation, Frequency Jump, Upper/Lower Limits for Frequency Command, DC Braking at Run/Stop, PID Control including Pause Function, Energy Saving Mode, Fault Reset, Traverse, etc.
Operating Environment	Area of Use	Indoor without corrosive gas/liquid or flammable gas/liquid/oil mist/dust
	Surrounding Air Temperature	-10°C to +50°C, below 90% RH without froze or condensation
	Storage Temperature	-20°C to +60°C
	Surrounding Area	Free from water, oil, metal shavings or othr foreign materials. Free from flammable materials (e.g., wood). Free from harmful gases and liquids. Free from direct sunlight. Free from oil mist, corrosive gas, flammable gas or dust. Free from radioactive material. Pollution Degree 2.
	Altitude	Up to 1000 meters
	Shock	Below 9.8 m/s ² (10 to 20Hz), below 5.9 m/s ² (20 to 55Hz)
	Enclosure	IP20
I/O	Analog Input (AI)	1 point (AI: 0 to 5V, 0 to 10V (12 bits), 0 or 4 to 20mA(11 bits))
	Digital Input (DI)	6 points
	Analog Output (AO)	1 point (FM: 0 to 10V (10bits))
	Digital Output (DO)	0
	Relay Output (RO)	1 point
Communications	Modbus (RS-485 port)	
Option Card	Profibus-DP, CANopen, DeviceNet	
Short-Circuit Current	Under 5000A. Relatively maximum voltage is 480 V circuit.	
Certificate	UL 508C, CSA C22.2 no .14, IEC 61800-5-1, IEC 61800-3	

*1. Results tested in labs

2.7 Product Dimensions

Frame Size 1

200V:

EVO600021S0D2E20F, EVO600021S0D4E20F, EVO600021SD75E20F, EVO600023S0D2E20,
EVO600023S0D4E20, EVO600023SD75E20, EVO600023S1D5E20

400V:

EVO600043S0D4E20F, EVO600043SD75E20F, EVO600043S1D5E20F

Frame Size 2

200V:

EVO600021S1D5E20F, EVO600021S2D2E20F, EVO600023S2D2E20, EVO600023S3D7E20

400V:

EVO600043S2D2E20F, EVO600043S3D7E20F

Frame Size 1

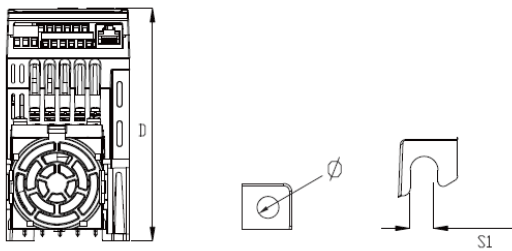
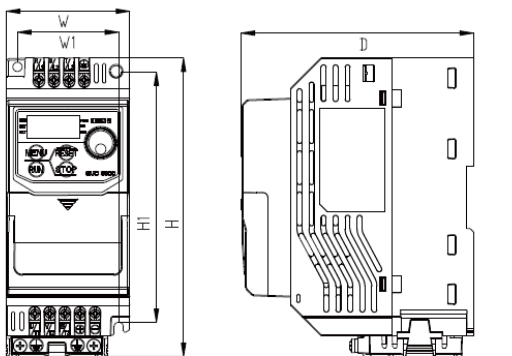

Frame Size 2

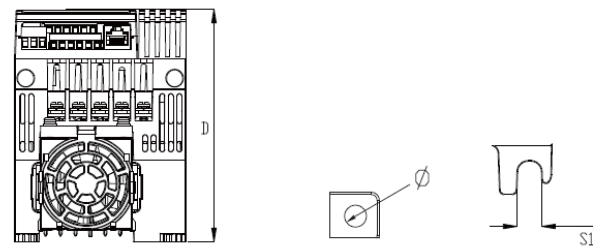
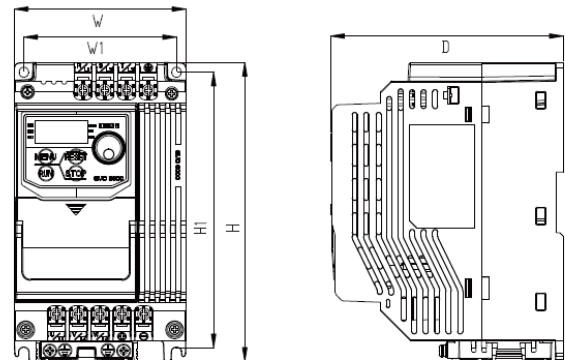

Series	Frame	W	W1	H	H1	D	S1	Φ
EVO6000	1	72[2.83]	59[2.32]	174.2[6.86]	151.6[5.97]	135.6[5.34]	5.4[0.21]	5.4[0.21]
	2	100[3.94]	89[3.50]	174.2[6.86]	162.6[6.41]	135.6[5.34]	5.8[0.23]	5.4[0.21]

Unit: mm/inch

Chapter 3 | Drive Installation

3.1 Installation Environment

To ensure the optimum drive performance, install the AC drive in a proper environment specified below.

Environment	Conditions
Area of Use	Indoors
Ambient Temperature	<ul style="list-style-type: none"> ● -10°C to +50°C (IP20 enclosure) ● Do not install the drive in environments with wide temperature fluctuations so as to ensure the drive reliability. ● When the drive is installed in an enclosure cabinet, make sure the cooling works properly to keep the temperature within the specified levels. ● Do not allow the drive to freeze. ● When drives are installed side-by-side in a cabinet, follow the instruction illustrated in Figure 3.2 to ensure the air flow.
Humidity	<ul style="list-style-type: none"> ● Under 90% RH ● Free of condensation
Storage Temperature	-20°C to +60°C
Surrounding Area	<ul style="list-style-type: none"> ● Free from water, oil, metal shavings or other foreign materials. ● Free from flammable materials (e.g., wood) ● Free from harmful gases and liquids ● Free from direct sunlight ● Free from oil mist, corrosive gas, flammable gas or dust. ● Free from radioactive material ● Green Class 2 or above
Altitude	Up to 1000 m without derating. Up to 2000 meters with 1% rated current derated for every 100 m counted from 1000 m.
Vibration	<ul style="list-style-type: none"> ● 10 to 20 Hz at 9.8 m/s² ● 20 to 55 Hz at 5.9 m/s²
Enclosure	IP20

3.2 Installation Direction and Spacing

3.2.1 Installation Direction

Install the AC drive upright for better cooling.

OK

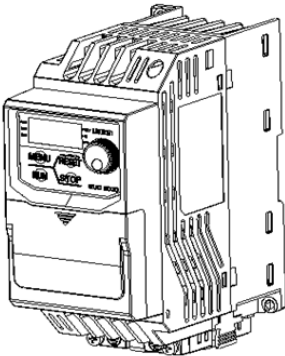

a. Upright installation

NG

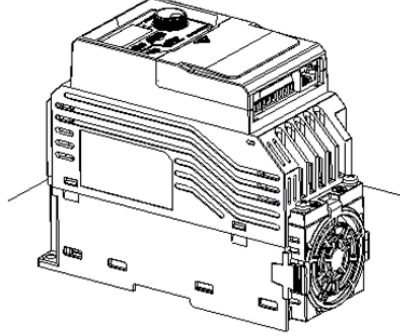

b. Horizontal installation

NG

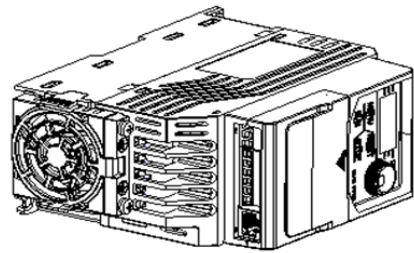

c. Transverse installation

Figure 3.1 Installation Direction

3.2.2 Installation Spacing

3.2.2.1 Single Drive Installation

Install the AC drive as illustrated below to ensure the required space for airflow and wiring.

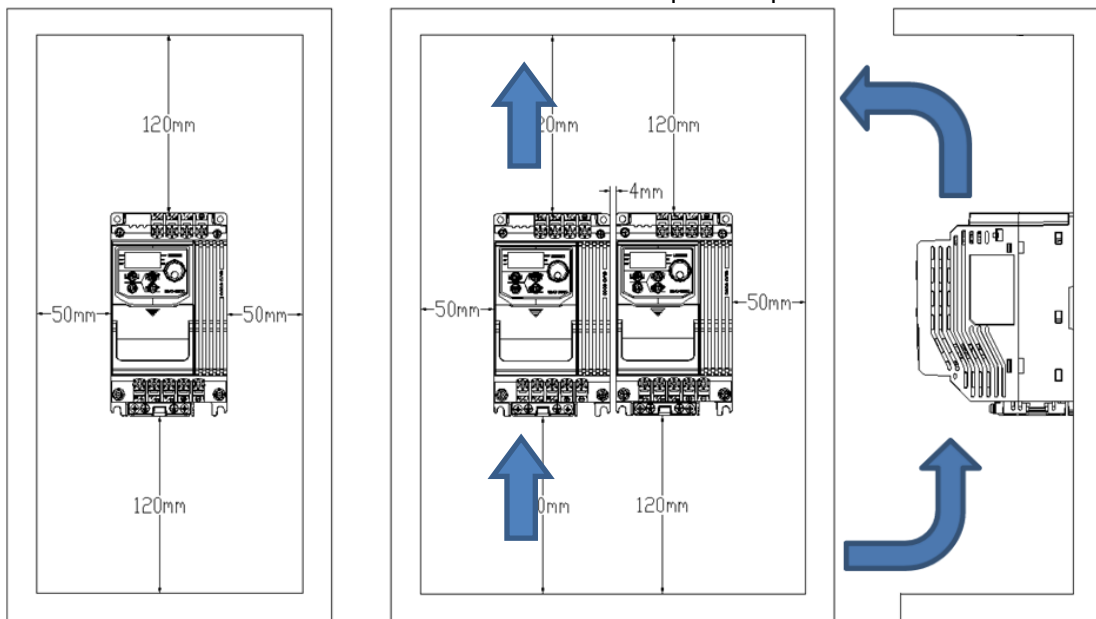
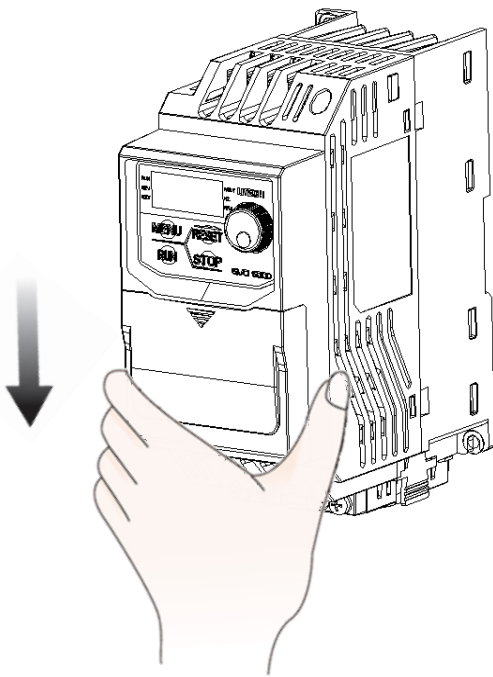

Figure 3.2 Installation Spacing

Note: When installing drives of different sizes, align the tops of the drives for easier cooling fan replacement.

3.3 Keypad and Terminal Cover Installation

It is not necessary to remove the keypad before wiring. You just need to loosen the terminal cover screw and remove the terminal cover. After wiring, affix the terminal cover back in position and tighten the screw. For wiring instructions and screw tightening torque please refer to Chapter 4.



Step 1: Slide the terminal cover down

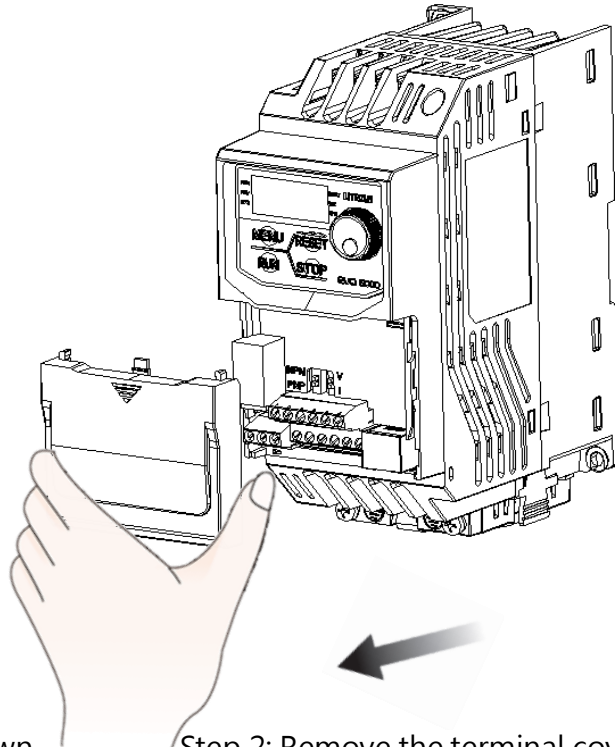

Step 2: Remove the terminal cover

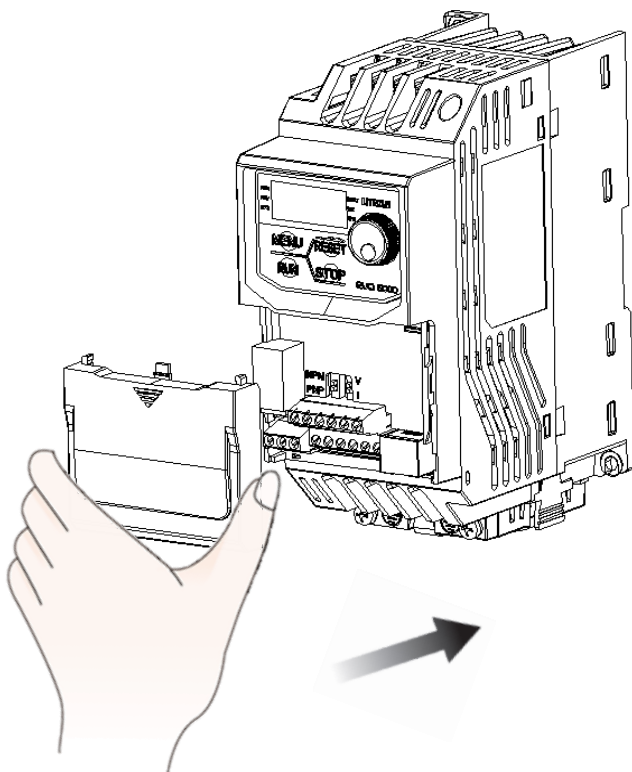

Step 3: Affix the Terminal Cover After Wiring

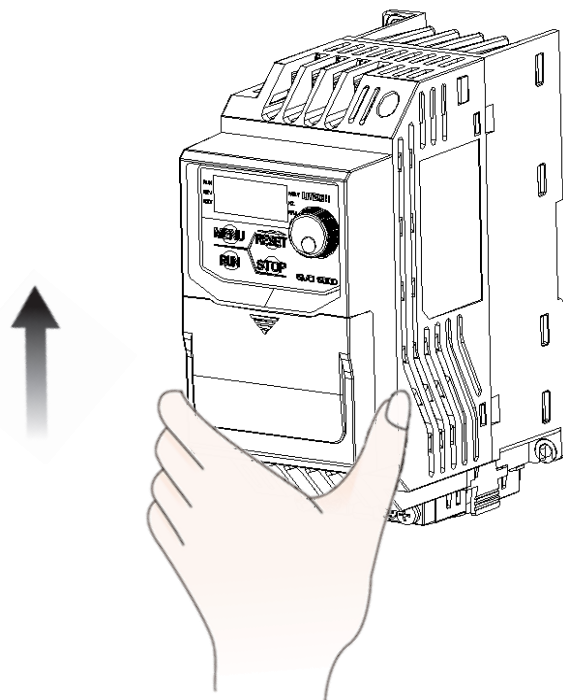

Step 4: Slide the terminal up

3.4 Wiring Protection

3.4.1 Drive and Input Cable Protection for Short-Circuit Situations

Protect the drive and input power cable by using fuse in case potential short-circuit situations cause overheat. Please refer to the following figure for proper wiring.

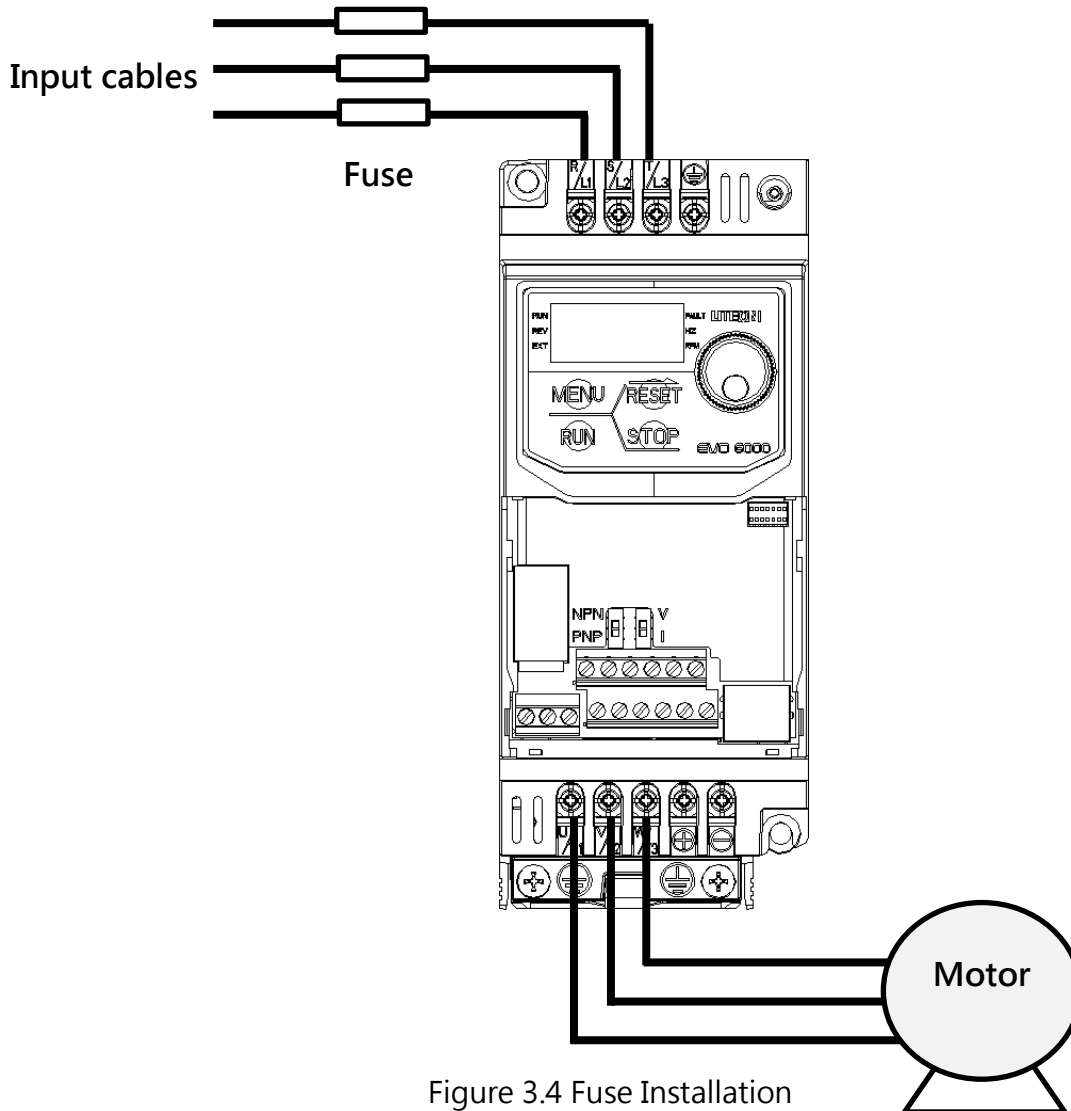

3.4.2 Motors and Output Cable Protection for Short-Circuit Situations

If the output cables are properly selected according to the drive rated current, the drive itself is fully capable of protecting the motor and output cables in case of short-circuit situations.

Note: If a single drive runs more than 1 motor, a separate thermal overload switch or a circuit breaker is required.

Chapter 4 | Wiring

4.1 Wiring Safety

Danger

- Turn off all the power to the equipment before wiring. Wiring during power on could cause electrical shocks to personnel.
- Allow only qualified personnel for installation, wiring, repairing and parts replacement.
- Capacitors in the drive may still be charged for a short time after shutting off the power. Wait for the amount of time specified on the drive before any maintenance.
- Never touch input or output power cables. Do not connect any circuit to drive enclosure.

Warning

- Properly connect the motor ground terminal. Contacts between the motor ground terminal and motor enclosure could cause electrical shocks or a fire.
- Ensure terminal screws are all tightened. Loose connection to the main circuit could cause overheat or a fire.
- Verify if the rated voltage of the drive matches the voltage of the incoming power supply before applying power.
- Perform all wiring as specified in the wiring diagrams provided when installing braking unit. Failure to comply could result in drive, braking unit or resistor damage on fire.
- Do not disconnect the motor from the drive while the drive is outputting voltage.
- Do not use unshielded cable for control circuit wiring. Failure to comply could cause abnormal operation of drive.
- Use shielded twisted-pair cables and connect the shield to ground terminal of the drive.
- Do not modify the drive circuits. Failure to comply could cause drive damage.
- Ensure all connections are correct after connecting the drive with other devices.
- Integral solid state short circuit protection does not provide branch circuit protection. Branch circuit protection must be provided in accordance with the National Electrical Code and any additional local codes” , or the equivalent
- Overtemperature protection is not provided by the drive.

4.2 Main Circuit

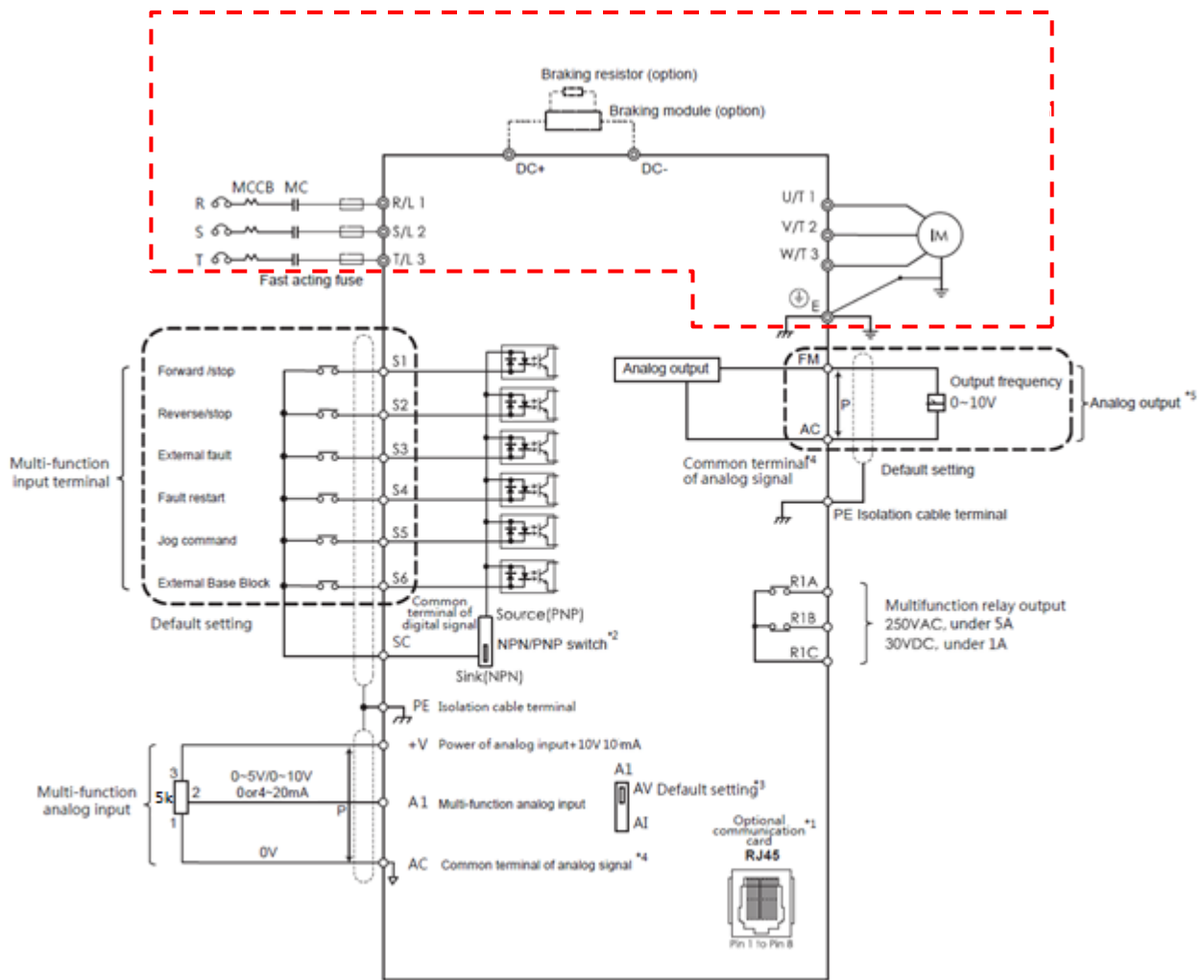

- ⊙ indicates main circuit
- indicates control circuit
- ⋯ indicates shielded cable
- ⋈ indicates twisted-pair shielded cable

■ Ensure the Stall Prevention function is off when using a braking unit.

4.2.1 Main Circuit Terminal

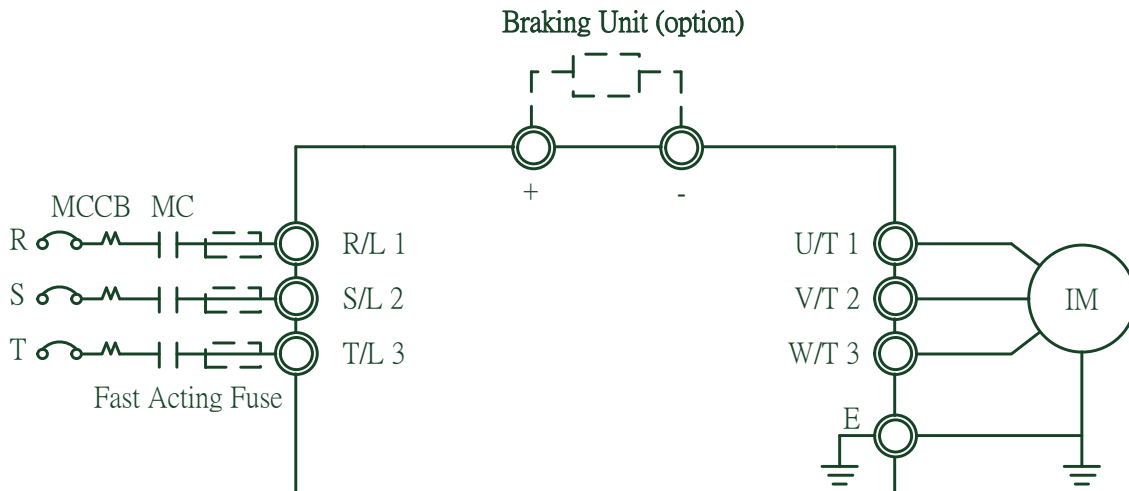

Table 4.2.1 Main Circuit Terminals

Terminal Name	Terminal Description
R/L1, S/L2, T/L3	Power input terminal
U/T1, V/T2, W/T3	Power output terminal
+, -	Braking unit terminal. Select option as per the specifications.
E	Ground terminal

4.2.2 Main Circuit Wiring

4.2.2.1 Power Input Terminal

- Install a molded case circuit breaker (MCCB) between three phase AC input power and main circuit terminals R/L1, S/L2 and T/L3. A magnetic contactor (MC) in series connection is also suggested so as to shut off the power by drive protection functions. Install a R-C varistor on both ends of the MC.
- Ensure main circuit terminal screws are tightened to avoid vibration loosening the screws which could cause electric sparks.

4.2.2.2 Power Output Terminal

- When connecting a noise filter at AC drive output terminals U/T1, V/T2 and W/T3, always use an inductive L-filter. Do not install any power capacitor, L-C or R-C filter.
- Connect AC drive output terminals U/T1, V/T2 and W/T3 to motor input terminals U, V

and W respectively. Ensure the motor and drive terminals are in same phase sequence or the motor will rotate reversely.

- Do not connect power cable to output terminals of the drive. Failure to comply could cause drive damage and a fire.

4.2.2.3 Braking Unit Terminal:

- If the drive is used in a high-frequency or heavy duty application which requires frequent braking or shorter deceleration time, install an optional braking unit to increase the braking torque.

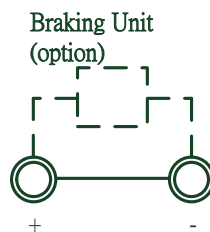

- Please refer to the wiring diagram when installing braking unit.

4.2.2.4 Ground Terminal

- Use grounding cables of dimensions regulated by electrical equipment standard. Shrink wiring distance to prevent leakage current resulting unstable electrical potential at the terminal distant from grounding terminal.
- Do not use share the same grounding cable with welding machines or any device requiring large current. Failure to comply could cause drive or equipment malfunction.
- Do not wind the grounding cable when multiple drives are installed. Failure to comply could cause drive or equipment malfunction.
- Ensure the neutral of the input side and drive terminal " \oplus " are grounded according to the local electrician regulations. 3WYE (e.g. TN and TT) system are suggested for the drive primary side.

4.2.2.5 Jumper

- EVO6000 complies with the European LVD standard EN 61800-5-1 (2007) reducing the current leakage to below 10mA DC under testing condition regulated by IEC 60990 (1999).

- Follow the instructions below to remove the jumper if an even lower current leakage to a even lower level.
- Removing the jumper may increase the signal interference.

1. Front right corner of the machine, remove the screw using a screwdriver.

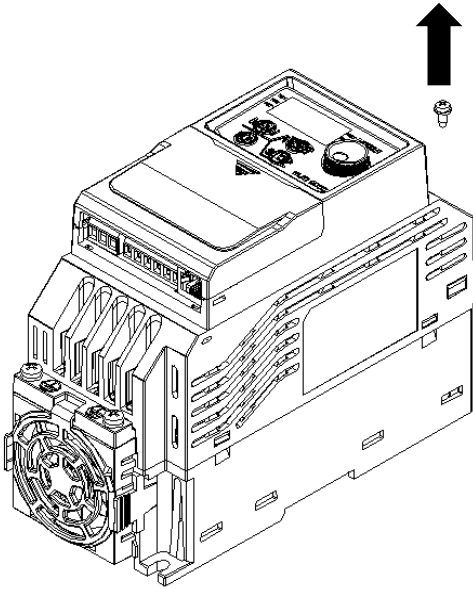

2. Remove the top right corner of the right side of the ground blade screw and save.

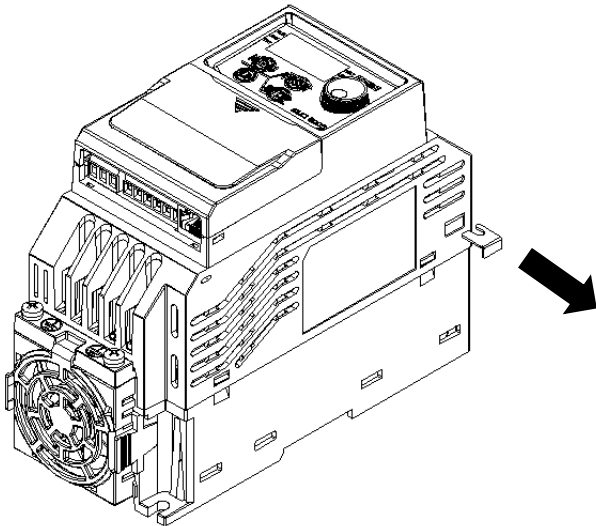

4.2.3 Main Circuit Cable Size and Tightening Torque

Select the cables and crimp terminals according to Table 4.2.2.

1. The recommended cables (copper conductors) are 600 V vinyl-sheathed cables which has

continuous temperature tolerance up to 75°C with ambient temperature tolerance up to 40 °C and wiring distance up to 100 meters.

2. Terminal + and - are only for connecting DC reactor and braking resistor options. Do not connect it to other devices.

3. Consider the amount of voltage drop when selecting cable sizes. Increase the cable size when the voltage drop exceeds 2% of the motor rated voltage. The amount of voltage drop can be calculated using the following formula:

$$\text{Line drop voltage (V)} = 3 \times \text{cable resistance } (\Omega/\text{km}) \times \text{cable length (m)} \times \text{current (A)} \times 10^{-3}$$

Table 4.2.2 Cable Size and Tightening Torque (Three-phase 400 V & single phase 200V)

Drive Frame	Terminal	USA		Europe & Asia		Terminal Screw Thread	kgf-cm (in-lbf)
		Suggested Cable Size AWG, kcmil	Applicable Cable Size AWG, kcmil	Suggested Cable Size mm2	Applicable Cable Size mm2		
Frame 1	R, S, T, U, V, W, PE	12	12 to 18	3.3	3.3 to 0.8	M3	14.2-16.3 (12-14)
Frame 2	R, S, T, U, V, W, PE	8	8 to 18	8.4	8.4 to 0.8	M4	16.3-19.3 (14-17)

4.3 Control Circuit

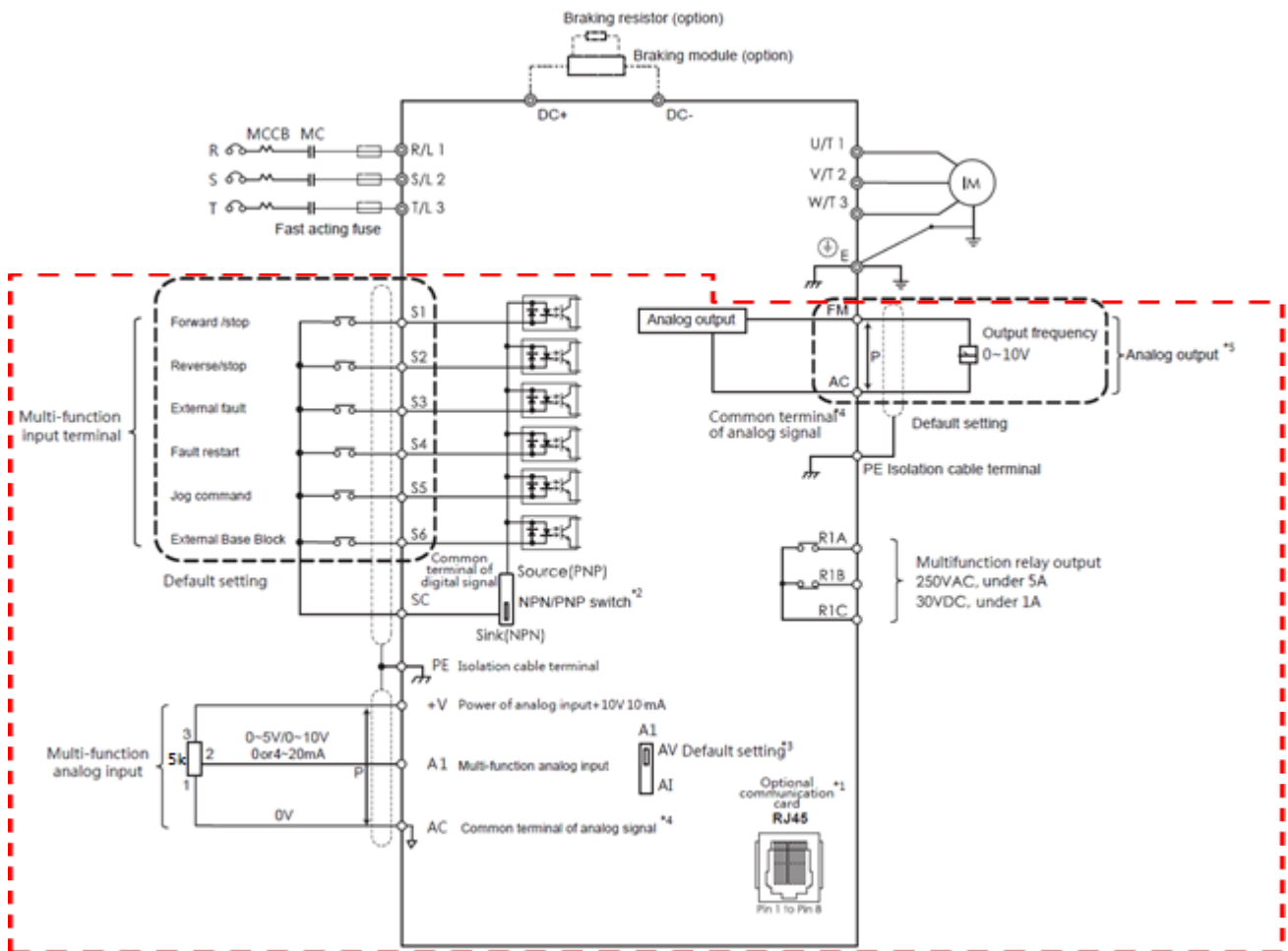

- ⊙ indicates main circuit
- indicates control circuit
- ⋯ indicates shielded cable
- ↔P indicates twisted-pair shielded cable

- RJ45 port can be connected to the built-in RS-485 communication or option communication cards (options cards are under development)
- Multi-function analog input S1 to S6 can be switched between Sink (NPN) mode and Source (PNP) mode. The default setting is NPN mode.
- DIP switch A1 is used to set the analog input type as voltage or current.
- AC (Analog Common) is the common terminal of analog signal.
- Analog output is used to connect a frequency meter, current meter, voltage meter and power meter.

- +V is the input terminal for auxiliary power.

4.3.1 Control Circuit Terminals

4.3.1.1 Input Terminals

Table 4.3.1.1 Control Circuit Input Terminal

Terminal Type	Terminal Code	Terminal Name	Terminal Description
Multi-Function Digital Inputs	S1	Digital input terminal 1 (forward/stop)	Photocoupler, 24 V, 8 mA. Use NPN/PNP switch to select multi-function digital input type. The default is NPN mode.
	S2	Digital input terminal 2 (reverse/stop)	
	S3	Digital input terminal 3 (external fault 1)	
	S4	Digital input terminal 4 (fault reset)	
	S5	Digital input terminal 5 (Jog)	
	S6	Digital input terminal 6 (Baseblock)	
	SC	Digital input common terminal for NPN/PNP mode switch. Select the mode correctly when connecting.	
Multi-Function Analog Inputs	+V	Auxiliary power terminal +10V (10mA)	Analog input power+10V
	A1	Analog input terminal 1 (main frequency command)	Voltage input: 0 to 5V or 0 to 10V Current input: 0 or 4 to 20mA
	PE	Ground terminal	The ground terminal for control signals to avoid interference. Use shielded cables only.
	AC	Common terminal for analog signals	

4.3.1.2 Output Terminals

Table 4.3.1.2 Control Circuit Output Terminals

Terminal Type	Terminal Code	Terminal Name	Terminal Description
Multi-Function Relay Output	R1A	Relay 1 normal open	Relay output DC 30 V, 1 A AC 250 V, 5 A
	R1B	Relay 1 normal closed	
	R1C	Relay 1 common	
Multi-Function Analog Output	FM	Programmable analog output terminal (output frequency)	Voltage Output 0 to 10V
	AC	Analog common terminal	

<1> Do not assign frequent switching functions such as ON/OFF to terminals R, which may

shorten the relay terminal life.

4.3.2 Control Circuit Wiring

The applicable functions in parameter Group E can be assigned to multi-function digital inputs (S1 to S6), multi-function relay outputs (R1), multi-function analog input (A1) and multi-function analog output (FM). The default settings are listed in Figure 4.3.1.1 and Figure 4.3.1.2.

- For safety, always check the emergency stop operation after wiring. Emergency stop circuit is necessary to stop the drive immediately in a safe manner to prevent any injuries.
- Do not remove the drive covers or touch the circuit boards when the power is on. Failure to comply could cause electrical shocks to personnel.
- Separate control circuit wiring from main circuit wiring and other power lines. Failure to comply could cause drive malfunction.
- Insulate shielded cable with tape to avoid contact with equipment and other signal lines. Improper insulation could cause drive or equipment malfunction.
- Always use shielded twisted-pair cables to prevent drive and equipment malfunction cause by electrical interference.
- Ground the shield to the ground terminal of drive. Failure to comply could cause erroneous operation or damage to the drive and equipment. Wire ground terminal and main circuit terminals before wiring control circuit terminals.

4.3.3 Control Circuit Cable Size and Tightening Torque

Select the cable according to Table 4.3.3.1. Use crimp ferrules on the cable ends for simpler and more reliable wiring.

Table 4.3.3.1 Cable Size and Tightening Torque

Terminal	Bare Cable		Ferrule-Type Terminal		kgf-cm(in-lbf)	Cable Type
	Applicable Size mm ² (AWG)	Suggested Size mm ² (AWG)	Applicable Size mm ² (AWG)	Suggested Size mm ² (AWG)		
S1, S2, S3, S4, S5, S6, SC, +V,A1, AC, FM, PE	0.26 ~ 1.31 (23 ~ 16)	0.13 ~ 2.08 (26 ~ 14)	0.41 ~ 1 (17 ~ 21)	1.3 ~ 0.3 (22 ~ 16)	5.1-8.1 (4.4-7in-lbf)	Shielded cable, etc.
R1A, R1B, R1C	0.26 ~ 1.65 (23 ~ 15)	0.13 ~ 3.31 (26 ~ 12)	4.17 (11)	3.31 ~ 5.26 (12 ~ 10)	5.1-8.1 (4.4-7in-lbf)	Shielded cable, etc.

4.3.4 Ferrule-Type Terminals

Always use ferrule-type terminals with insulated sleeves. Refer to Table 4.3.3.2. for dimensions. In addition, crimping tool CRIMPFOXZA-3 manufactured by Phoenix Contact is recommended.

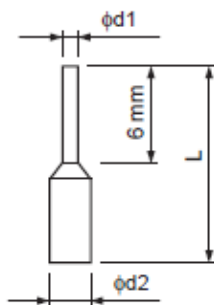

Table 4.3.3.2 Ferrule-Type Terminal Models and Sizes

Cable Size mm ² (AWG)	Type	L (mm)	d1 (mm)	d2 (mm)	Manufacturer
0.25 (24)	AI 0.25-6YE	10.5	0.8	2	Phoenix Contact
0.34 (22)	AI 0.34-6TQ	10.5	0.8	2	Phoenix Contact
0.5 (20)	AI 0.56-WH	14	1.1	2.5	Phoenix Contact

4.4 I/O Connections

4.4.1 NPN and PNP Mode Selection

Use Sink/Source DIP switch on the control board to set NPN/PNP (Sink/ Source) mode for multi-function digital inputs S1 to S6. (Default: NPN mode)

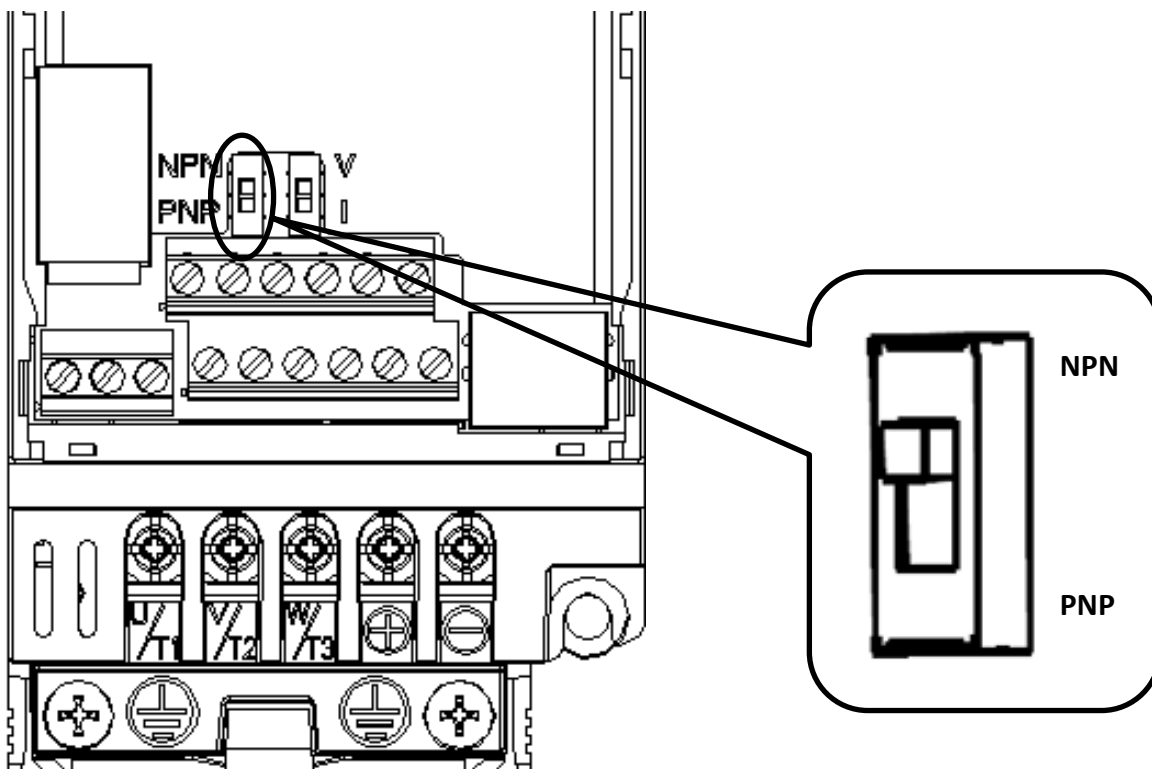

Figure 4.4.1 NPN/PNP (Sink/Source) DIP Switch

4.4.2 Terminal A1 Voltage/Current Input Selection

Select voltage or current input at terminal A1

- To select current as the input type, set DIP switch A1 to I and set parameter E3-00 to 0 (0 to 20 mA) or 1 (4 to 20 mA).
- To select voltage as the input type, set DIP switch A1 to V and set parameter E3-00 to 2 (0 to 10 V) or 3 (0 to 5 V).

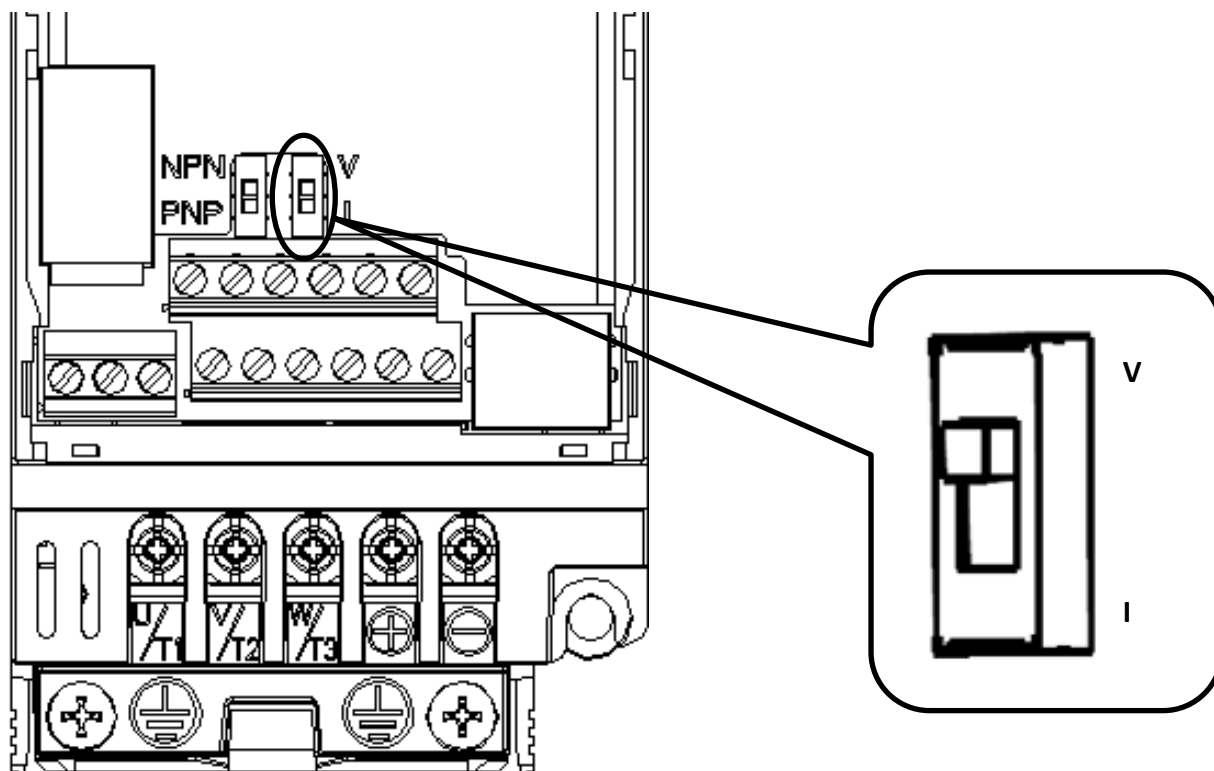

Figure 4.4.2 DIP Switch A1

Table 4.4.1 DIP Switch A1 Settings (Terminal A1)

Setting	Description
V	Voltage input (0 to 10 V (default) or 0 to 5 V)
I	Current input (4 to 20 mA or 0 to 20 mA)

4.5 Wiring Checklist

Table 4.6 Wiring Checklist

<input type="checkbox"/>	No.	Item	Page
Power Supply Voltage and Output Voltage			
<input type="checkbox"/>	1	Power supply voltage is within the voltage range of specified drive input.	
<input type="checkbox"/>	2	The motor voltage matches the drive output specifications.	
<input type="checkbox"/>	3	The drive rating matches the motor rating.	
Main Circuit Wiring			
<input type="checkbox"/>	4	An MCCB of proper specifications is connected between the drive and motor.	
<input type="checkbox"/>	5	Power cables are correctly connected to drive input terminals R/L1, S/L2 and T/L3.	
<input type="checkbox"/>	6	Motor terminals and drive terminals U/T1, V/T2 and W/T3 are in same phase sequence. (Otherwise the motor will rotate reversely)	
<input type="checkbox"/>	7	Power supply and motor power cable complies with electrician regulations.	
<input type="checkbox"/>	8	The drive is properly grounded.	
<input type="checkbox"/>	9	Drive terminal screws of the main circuit and ground are tightened.	
<input type="checkbox"/>	10	<p>An MC is installed for each motor if a single drive runs more than on motor.</p> <div data-bbox="395 1093 1241 1361" style="text-align: center;"> <p style="text-align: center;">MC1~MCn Magnetic Contactor</p> </div> <p>Note: Set MC1 to MCn OFF before operating the drive. Do not switch MC1 to MCn ON or OFF during run.</p>	
<input type="checkbox"/>	11	When using a braking resistor or braking unit, an MC is installed on the drive input side and able to shut off the power to drive when overloaded.	
Control Circuit Wiring			
<input type="checkbox"/>	12	Twisted-pair cables are used for all drive control circuit wiring.	
<input type="checkbox"/>	13	Shielded cables are connected to the terminals.	
<input type="checkbox"/>	14	Options (if any) are properly installed.	
<input type="checkbox"/>	15	No wiring mistakes.	
<input type="checkbox"/>	16	Do not use a buzzer to check wiring.	
<input type="checkbox"/>	17	The control circuit terminal screws are tightened.	
<input type="checkbox"/>	18	No cable clippings or screws are left inside the drive enclosure.	
<input type="checkbox"/>	19	Control circuit wiring and main circuit wiring are separated.	

Chapter 5 | Keypad

5.1 Check before Operation

- Make sure the main circuit is properly wired. R/L1, S/L2 and T/L3 are power input terminals which cannot be mixed with U/T1, V/T2, W/T3. Failure to comply could cause damage to the AC drive.
- Make sure the ground terminal is properly wired.
- Make sure the drive capacity matches the related parameter settings.
- Do not use the drive with wet hands.
- Check the connected machinery status before Auto-Tuning to ensure personnel safety.
- Drives could increase the motor speed rapidly. Ensure appropriate speed tolerance for the motor and machinery.
- When using options such as a braking unit, always follow its instructions.
- Drives can only operate in environment with -10°C to +50°C, below 90% RH and free from condensation, metal shavings or liquid.

5.2 Powering Up the Drive and Operation Status Display

- Power Up

Check the following table before applying the power supply.

Table 5.2.1 Check List before Power Up

Item to Check	Description
Power supply voltage	400 V : Three-phase AC 380 V to 480 V, 50/60 Hz
	Properly wire the power input terminals R/L1, S/L2 and T/L3.
	Ensure proper grounding of AC drive and motor.
Status of drive output terminals and motor terminals	Ensure the drive output terminals (U/T1, V/T2 and W/T3) are wired properly with motor terminals (U, V and W).
Status of control circuit terminals	Ensure the drive control circuit terminals are wired properly with other control device.
Status of drive control terminals	Ensure all the drive control circuit terminals are open.
Status of the load and connected machinery	Check if the motor is connected to the machinery.

5.3 Keypad











Use the keypad to enter RUN and STOP commands, display data, fault, alarm and set parameters.

5.3.1 Keys and Displays



Figure 5.1.1 Keypad





























Table 5.3.1 Keypad Keys and Displays

No	Display	Name	Function
1		MENU Key	<ul style="list-style-type: none"> ■ Enters or exits the parameter group ■ Switches the displayed menu
2		RUN Key	Forward/reverse selection
3		STOP Key	Stops the drive. Refer to Table 5.1.2.2
4		RESET Key	<ul style="list-style-type: none"> ■ Moves the cursor to the right Resets the drive to clear a fault situation
5		Non-Slip Setting Dial	<p>Press it as “ENTER” key:</p> <ul style="list-style-type: none"> ■ Enters parameter value, parameter and setting ■ Enters parameter setting menu. ■ Confirms the frequency set by the dial <p>Press it as “Dial” key: Increases or decreases parameter numbers, setting value and frequency</p>
6		RUN Light	Refer to Table 5.3.2.2
7		REV Light	Refer to Table 5.3.2.2
8		EXT Light	Refer to Table 5.3.2.2
9		Fault Light	Refer to Table 5.3.2.2
10		Hz Light	Refer to Table 5.3.2.2
11		RPM Light	Refer to Table 5.3.2.2

5.3.2 Keypad Display







5.3.2.1 LED Display

Table 5.3.2.1 LED Display

Number /Letter	LED Display	Number /Letter	LED Display	Number /Letter	LED Display	Number /Letter	LED Display
0		9		i		r	
1		A		J		S	
2		b		K	Nil	t	
3		c		L		U	
4		d		M	Nil	v	
5		E		n		W	Nil
6		F		o		X	Nil
7		G		P		y	Nil
8		H		q	Nil	Z	Nil

5.3.2.2 LED Indication

Table 5.3.2.2 LED Indication

Indicator Light	Lit	Blinking	Off
	Drive in operation	<ul style="list-style-type: none"> ■ Drive in deceleration ■ Output frequency below the minimum frequency 	Drive not in operation
	Rotating reversely	Nil	Nil
	Allows Run commands only from a remote source	Nil	Nil
	During fault	Nil	Normal operation
	Displaying output frequency	Nil	Nil
	Displaying output speed	Nil	Nil

5.3.3 Keypad Programming

- Keypad Display Menu Structure

- A. Standard setting mode: Press MENU to switch among monitor group, A1-00 parameter group and A2-00 user-defined parameter group. Press ENTER, MENU, Non-slip setting dial, and RESET to monitor and edit settings.
- B. Holding MENU for 3 seconds for entering User Parameter A2-00
- C. During-operation setting mode: During operation in Local mode, use the non-slip setting dial to change the drive output frequency.
- D. Holding Non-slip setting dial for 3 seconds in menu level can enter forward and reverse switching page, for more detail please refer to parameter b1-13.

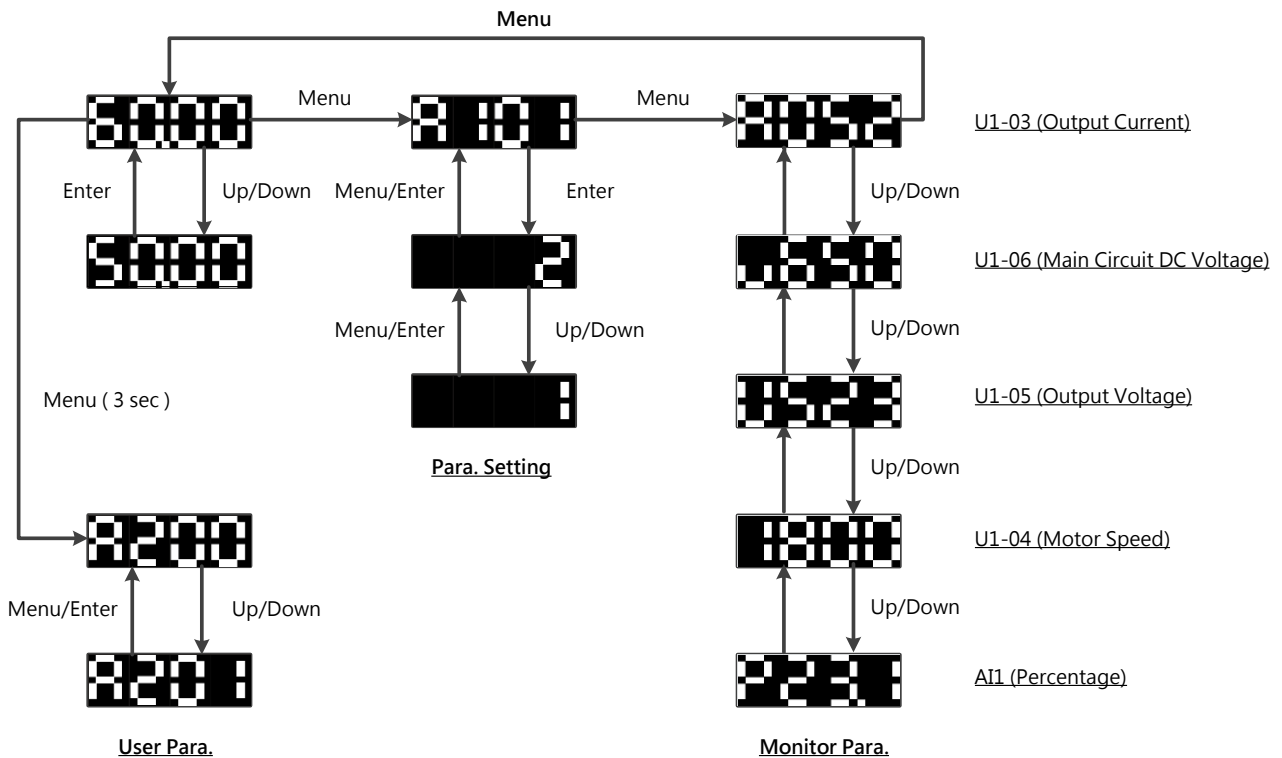

Chapter 6 | Parameters

6.1 Group A, Initialization

Sets the initial parameters (group A parameter) such as Access Level Selection, password and etc.

A1 Initialization

■ A1- 00 Retain

■ A1- 01 Access Level Selection

Selects access level (edit/ view)

No.	Name	Setting Range	Default
A1-01	Access Level Selection	0, 1, 2	2

0 : View Only

Access to only parameter A1-01

1 : User-Defined Parameter Access

Access to only parameter A1-01 and A2-00 to A2-31

2 : All Parameter Access

All parameters can be edited and viewed

Note:

- Once the password is set to A1-05, user cannot edit A1-01, A1-03, A2-01 to A2-32 before entering the correct password in A1-04.
- Once E1-□□= 60 (Program Lockout) is set, user cannot edit any parameters before closing the assigned terminal, even when A1-01 = 1 or 2.
- When using Modbus communication to edit parameters, it is not possible to edit parameters via keypad until an ENTER command is given to the drive from the communication.
-

■ A1- 02 Control Method Selection

No.	Name	Setting Range	Default
A1-02	Control Method Selection	0, 1	0

0 : Open-Loop V/F Control

This method is recommended for those applications without the need of fast response, accurate speed control. Select this method also when using a single drive to run more than one motors, the motor parameters are unknown or Auto-Tuning cannot be performed. The speed control range is 1 : 40.

1 : Sensorless Voltage Vector Control (SVVC, Open-Loop)

This method is recommended for those applications which high torque at low speed and quick torque response without any speed feedback signal from the motor during speed adjustment. The speed control range is 1 : 100.

■ A1-03 Reset

Resets parameter settings to default settings. After resetting parameters, the value will automatically set to 0.

No.	Name	Setting Range	Default
A1-03	Reset	0 to 3646	o2-03

0: N/A

2520: Resets 2-Wire Sequence / 50Hz / 200V

2522: Resets 2-Wire Sequence / 50Hz / 220V

2523: Resets 2-Wire Sequence / 50Hz / 230V

2620: Resets 2-Wire Sequence / 60Hz / 200V

2622: Resets 2-Wire Sequence / 60Hz / 220V

2623: Resets 2-Wire Sequence / 60Hz / 230V

3520: Resets 3-Wire Sequence / 50Hz / 200V

3522: Resets 3-Wire Sequence / 50Hz / 220V

3523: Resets 3-Wire Sequence / 50Hz / 230V

3620: Resets 3-Wire Sequence / 60Hz / 200V

3622: Resets 3-Wire Sequence / 60Hz / 220V

3623: Resets 3-Wire Sequence / 60Hz / 230V

2538: Resets 2-Wire Sequence/ 50Hz / 380V

2541: Resets 2-Wire Sequence / 50Hz / 415V
 2544: Resets 2-Wire Sequence / 50Hz / 440V
 2546: Resets 2-Wire Sequence / 50Hz / 460V
 2638: Resets 2-Wire Sequence / 60Hz / 380V
 2641: Resets 2-Wire Sequence / 60Hz / 415V
 2644: Resets 2-Wire Sequence / 60Hz / 440V
 2646: Resets 2-Wire Sequence / 60Hz / 460V
 3538: Resets 3-Wire Sequence / 50Hz / 380V
 3541: Resets 3-Wire Sequence / 50Hz / 415V
 3544: Resets 3-Wire Sequence / 50Hz / 440V
 3546: Resets 3-Wire Sequence / 50Hz / 460V
 3638: Resets 3-Wire Sequence / 60Hz / 380V
 3641: Resets 3-Wire Sequence / 60Hz / 415V
 3644: Resets 3-Wire Sequence / 60Hz / 440V
 3646: Resets 3-Wire Sequence / 60Hz / 460V

Note:

- The parameter listed in Table 6.1 will not be reset when setting 2220 or 3330 to A1-03.
- A1-02 (Control Method Selection) will not be reset when setting 2220 or 3330 to A1-03.

Table 6.1 Parameters Not Subject to Reset

NO.	Name
A1-02	Control Method Selection
d1-01	V/F Pattern Selection
E6-05	Retain
P7-12	Installation Method Selection
o2-03	Drive Capacity Selection

■ **A1- 04/ A1- 05 Password**

Set password to parameter A1-05 and enter the password to parameter A1-04 to unlock it.

No.	Name	Setting Range	Default
A1-04	Password	0000 to 9999	0000
A1-05	Password Setting		

■ Password and Password Setting

- Once the password other than 0000 is set to A1-05, user cannot edit A1-01 to A1-03, A2-00 to A2-15. Enter the correct password in A1-04 to unlock parameter access.
- A1-04 will display " nULL" if password has never been set. The user can only set the password (A1-05). Once the password is set, A1-05 will display " LtH" . The user can only enter the set password (A1-04).

Follow the steps to set the password and enter password:

Table 6.2.1 Password Setting Steps















Step			
1	Turn on the power to the drive. The initial display appears.	➔	06000
2	Press  and select A1-04.	➔	A1-04
3	Press  to display A1-04 setting. "nULL" is displayed as the password has never been set.	➔	nULL
4	Press  to select A1-05.	➔	A1-05
5	Press  to display A1-05 setting.	➔	00000
6	Press  or  to set the password. (1234 is an example)	➔	01234
7	Press  to display A1-05 setting.	➔	A1-05
8	" LtH" is displayed when entering A1-05 setting.	➔	LtH

Table 6.2.2 Password Entering Steps

Step			
1	Press  and select A1-04.	➔	A1-04

2	Press  to enter A1-04 setting. "nULL" is not displayed anymore as the password has been set.	➔	
3	Press  or  to enter the correct password. (1234 is an example)	➔	
4	The display leaves A1-04 setting automatically as the parameters are unlocked.	➔	

■ **A2- 00 to A2- 15 User-Defined Parameters 1 to 16**

Selects up to 16 parameters and assigns them to parameter A2-00 to A2-31.

No.	Name	Setting Range	Default
A2-00 to A2-15	User-Defined Parameters 1 to 16	A1-00 to F1-25	

■ **Recently Edited Parameter Save**

Saved parameters can be viewed in User-Defined Parameter Access. To assign specific parameters to A2-00 to A2-15, set parameter A1-01 to 2. The saved parameters A2-00 to A2-15 can only be viewed if A1-01 is set to 1.

■ **A2-32 User-Defined Parameter Automatic Save**

Enables or disables the automatic save for A2-08 to A2-15.

No.	Name	Setting Range	Default
A2-32	User-Defined Parameter Automatic Save	0, 1	1

0 : Enabled

Sets A2-32 to 0 to save the parameter manually.

1 : Disabled

Automatically saves the most recently edited parameters started from A2-08 to A2-15 (maximum 8 parameters). When the edited parameters are more than 8, only the most recent 16 parameters will be saved while the old ones will be removed.

6.2 Group b, Application

b1: Operation Mode Selection

■ b1- 00 Frequency Command Selection 1

Selects the frequency command source for the REMOTE mode.

Note:

- When the run command is input with 0 Hz frequency command or below the minimum frequency, the RUN LED will blink.
-

No.	Name	Setting Range	Default
b1-00	Frequency Command Selection 1	0 to 3	0

0 : Keypad

Allows two ways to input the frequency command.

- Switching between the multi-step speed command in parameters L1-□□ (by digital input terminal).
- Entering the frequency command on the keypad.

1 : Control Circuit Terminal (Analog Input)

Allows a voltage or current input as analog frequency command from terminal A1.

- Voltage Input

Allows a voltage signal input via terminals A1. Refer to Table 6.4 for parameter settings.

Table 6.4 Frequency Command Using Voltage Signals

Terminal	Signal Level	Parameter Settings				Notes
		Signal Level Selection	Function Selection	Gain	Bias	
A1	0 to 10 V	E3-00 = 2	E3-01 = 0 (Main Frequency Command)	E3-02	E3-03	Ensure DIP switch A1 is placed to V (voltage)
	0 to 5 V	E3-00 = 3				

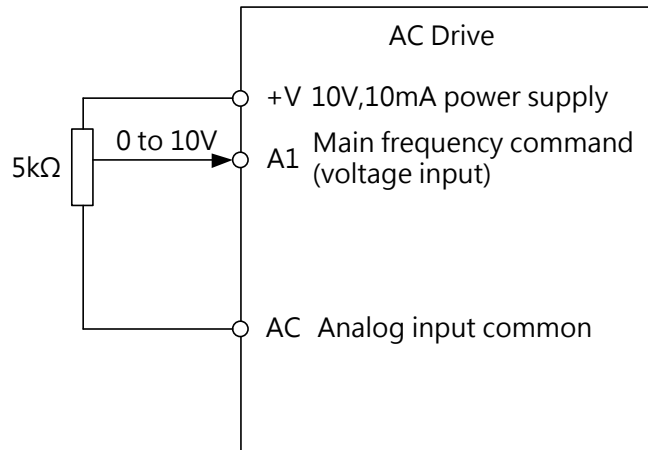

Figure 6.1 Setting Frequency Command as a Voltage Signal at Terminal A1

Wire all the analog input terminals according to Figure 6.1. Ensure DIP switch A1 is placed to V (voltage).

□ Current Input

Allows a current input via terminal A1. Refer to Table 6.5 for parameter settings.

Table 6.5 Frequency Command Using Current Signals

Terminal	Signal Level	Parameter Settings				Notes
		Signal Level Selection	Function Selection	Gain	Bias	
A1	0 to 20 mA	E3-06 = 0	E3-07 = 0	E3-08	E3-09	Ensure DIP switch A1 is placed to I (current)
	4 to 20 mA	E3-06 = 1				

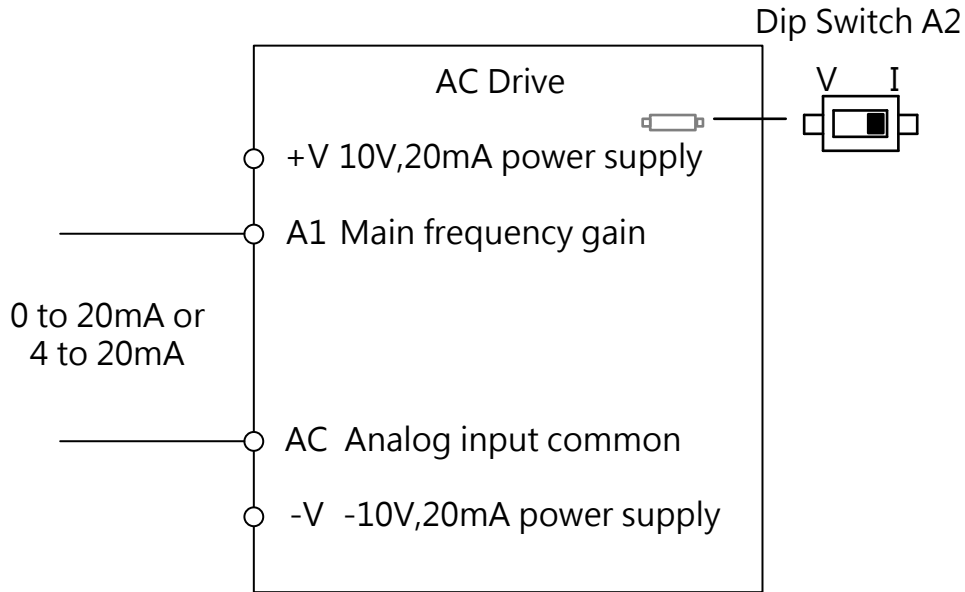

Figure 6.2 Setting Frequency Command as a Current Signal at Terminal A2

Ensure DIP switch A1 is placed to I (current).

- Switching between Main /Auxiliary Frequency Command

If analog input terminal A1 is set to 3 (Auxiliary Frequency Command), the multi-speed step 1 will follow analog input frequency command, for more detail please refer to table 6.12 "Multi-Step Speed Command and Multi-Function Terminal Combinations"

2 : Terminal UP/DOWN

Use digital input terminals S1 to S6 to increase or decrease the frequency.

3 : Modbus Communication

Allows frequency command via the Modbus communication. Make sure RS-485/422 serial communications port is connected to RJ45. For more details please refer to Chap.11

■ b1- 01 Run Command Selection 1

Selects the run command source for the REMOTE mode.

No.	Name	Setting Range	Default
b1-01	Run Command Selection 1	0 to 2	0

0 : Keypad

Allows the run command via the RUN key on the keypad.

1 : Control Circuit Terminal

Allows the run command via the digital input terminals using the following sequences.

□ 2-Wire Sequence

Two inputs (forward/stop, reverse/stop). Set E1-00 (Terminal S1 Function Selection) to 0 (Forward/Stop) and E1-01(Terminal S2 Function Selection) to 1(Reverse/Stop). Refer to Page 112 for instructions.

□ 3-Wire Sequence

Three inputs (forward, stop, forward/reverse). Set A1-03 = 3330 to reset the drive and automatically assign the 3-wire sequence control function to terminals S1, S2 and S5. Refer to Page 113 for instructions.

2 : Modbus Communication

Allows Run commands via the Modbus communication. Make sure RS-485/422 serial communications port is connected to control circuit terminals J1 and J4.

■ b1-02 Stopping Method Selection

Selects the way the drive stops the motor when a Stop command is entered or the run command is removed.

No.	Name	Setting Range	Default
b1-02	Stopping Method Selection	0 to 3	0

0 : Ramp to Stop

The drive will decelerate the motor according to the active deceleration time. The default of deceleration time is set in C1-01. The actual deceleration time will be changed depending on the load characteristics such as inertia.

When decelerating a load with high inertia, the drive perform ramp-to-stop first and then start DC braking to fully stop the motor. Refer to "b2 Group, DC Braking" for details.

□ For Open-Loop V/F Control, Closed-Loop V/F Control, Open-Loop Vector Control and PM Open-Loop Vector Control:

When the output frequency falls below b2-00, DC Braking is enabled for the time set in b2-03. Refer to Figure 6.3.

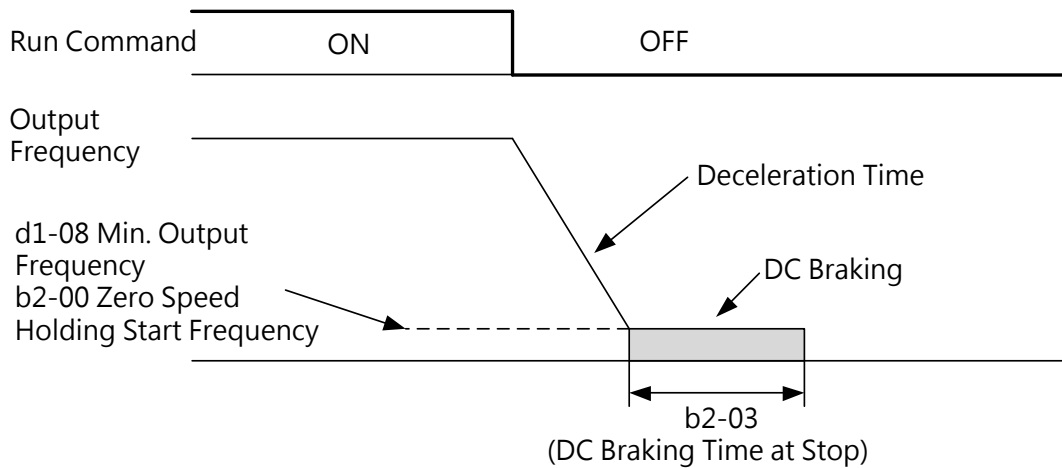

Figure 6.3 Ramp to Stop

Note: If the b2-00 value is smaller than the d1-08 value, DC Braking is enabled when the output frequency falls below the d1-08 value.

1 : Coast to Stop

When a Stop command is given, the drive will shut off its output. Then the motor will coast to stop for the time determined by the inertia and friction.

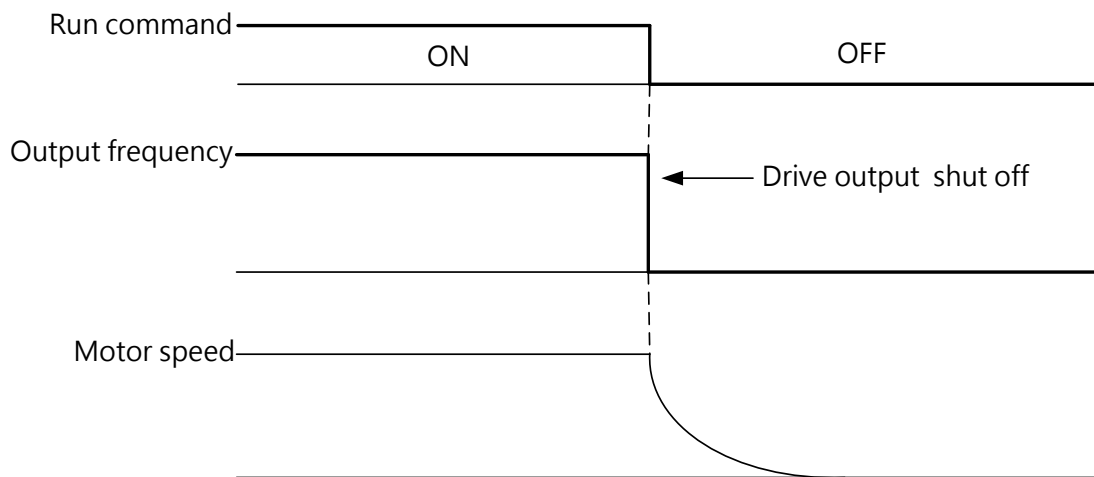

Figure 6.5 Coast to Stop

Note: After a Stop command is given, the drive will ignore any Run command entered until the minimum baseblock time set to P2-01. Do not enter Run command until the motor has completely stopped. To restart the motor before the complete stop, use DC braking at start (Refer to b2-02) or Speed Search (Refer to b3).

2 : DC Braking to Stop

When a Stop command is given, the drive will enter the current set to b2-01 to the motor after waiting the minimum baseblock time set to P2-01. DC Braking to Stop significantly shorter the stopping time compared to Coast to Stop.

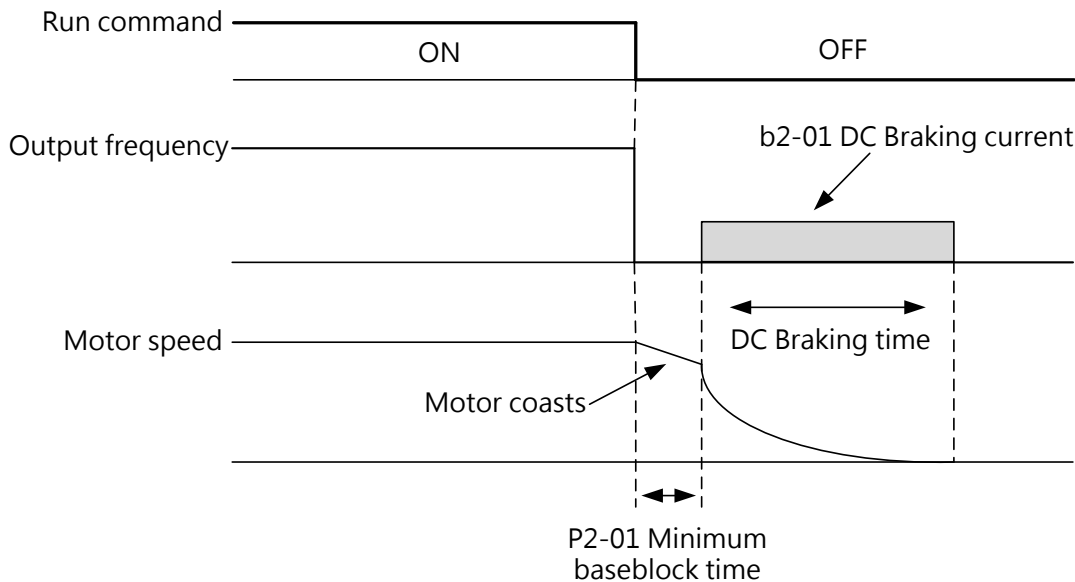

Figure 6.6 DC Braking to Stop

DC Braking time is determined by b2-03 (DC Braking Time at Stop) and the output frequency when a Stop command was entered.

$$\text{DC Braking time} = (b2-03) \times 10 \times \text{Output frequency} / d1-02(\text{Maximum output frequency})$$

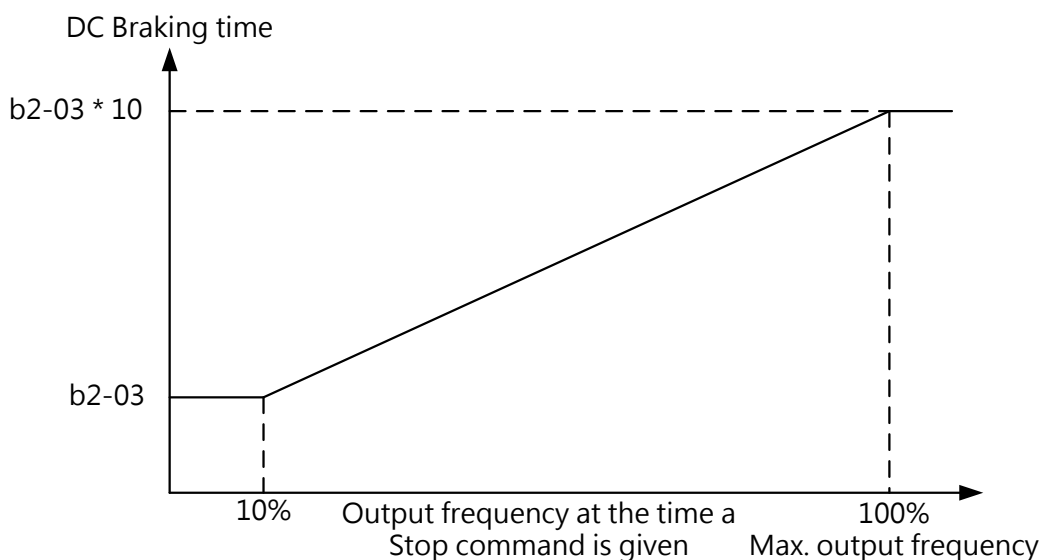

Figure 6.7 DC Braking Time Depending on Output Frequency

Note: If an OCD (Overcurrent) fault occurs, increase the minimum baseblock time to P2-01.

3 : Coast to Stop with Timer

When a Stop command is given, the drive shuts off its output and the motor will coast to stop. The drive will ignore any Run command until the wait time (t) ends.

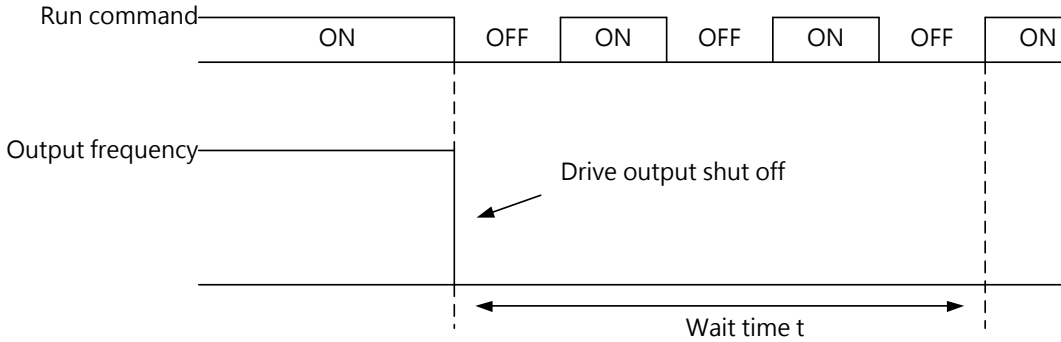

Figure 6.8 Coast to Stop with Timer

The wait time t is determined by the output frequency when the Stop command was given and by the active deceleration time.

For example, if the deceleration time is 10 seconds, the maximum frequency is 50Hz and the Stop command is entered when the speed is 25Hz, then the wait time is $(25\text{Hz}/50\text{Hz}) * 10\text{s} = 5\text{s}$.

■ b1-03 Reverse Rotation Selection

Determines whether reverse rotation is enabled. For some applications such as fans and pumps, reverse rotation could cause problems.

No.	Name	Setting Range	Default
b1-03	Reverse Rotation Selection	0, 1	0

0 : Reverse Rotation Enabled

Drive accepts a run command of both forward and reverse directions

1 : Reverse Rotation disabled

Drive can accept only run command of forward direction

■ b1-05 Run Command Action after Switch

The command source can be switched by pressing LO/RE key on the keypad, multi-function

terminal input E1-□□= 3 (LOCAL/REMOTE Selection), E1-□□= 4 (Command Source 1/2 Selection) . Refer to parameter group E1 and LO/RE Key Function Selection (o2-00).

Enables or disables the protection to avoid an active Run command at the new source causing a sudden movement on the motor when the command source is switched from the old source to the new source.

No.	Name	Setting Range	Default
b1-05	Run Command Action after Switch	0, 1	0

0 : Ignore Active Run Command at the New Source

If a Run command at the new source is active, the drive will not start or the drive will stop operation if it was running, when switching from the old source to the new source. The drive can start only when the Run command is removed and given again.

1 : Accept Active Run Command at the New Source

WARNING! If a run command at the new source is active, the drive will accept it and run the motor immediately right after switching from the old source to the new source. Clear all personnel from the electrical connections and the running machinery prior to switching command sources. Failure to comply could cause serious injury.

■ b1-06 Run Command Selection during Programming

For safety reasons, the drive will ignore a Run command when the keypad is being used to edit parameters in Programming Mode. If allowing a Run command during programming is required in the application, set this parameter to 1.

No.	Name	Setting Range	Default
b1-06	Run Command Selection during Programming	0 to 2	0

0 : Run command disabled during Programming

A Run command is not accepted when the keypad is being used to edit parameters in Programming Mode.

1 : Run command enabled during Programming

A Run command is accepted when the keypad is being used to edit parameters in Programming Mode.

2 : Prohibit programming during run

The programming mode cannot be displayed during run except for monitoring parameter Group U.

■ b1- 10 Run Command at Power up

Determines to accept or ignore an active Run command from Remote during power up.

No.	Name	Setting Range	Default
b1-10	Run Command at Power up	0,1	0

0 : Ignore

Drive ignores an active run command during power up.

Note: The LED indicator blinks when there is an active Run command from Remote during power up. The drive can start only when the Run command is removed and entered again.

1 : Accept

Drive accepts an active Run command from Remote during power up and starts the motor immediately

WARNING! The drive will run the motor immediately at power up if there an active Run command from Remote. Ensure the protection measures are taken and clear all personnel from the electrical connections and the running machinery prior to switching command sources. Failure to comply could cause serious injury.

■ **b1- 12 Allowing Local/Remote selection during run**

No.	Name	Setting Range	Default
b1-12	Allowing Local/Remote selection during run	0,1	0

0 : Disable

Local / Remote cannot be switched even the Local / Remote terminal is ON during run.

1 : Enable

Local / Remote can be switched when the Local / Remote terminal is ON during run.

For the sake of safety, if the command has been switched from Remote to Local, the drive will remain frequency and run command from remote side, but if the command has been switched from Local to Remote, the drive will operate depends on the frequency and run command from remote side immediately. (Parameter b1-12 is not limited by b1-05)

WARNING! Please make sure the frequency and run command is correct when switching Local to Remote during run.

■ **b1- 13 Forward/Reverse Selection from keypad**

No.	Name	Setting Range	Default
b1-12	Forward/Reverse Selection from keypad	0,1	0

0 : Disable

Forward and Reverse cannot be switch from keypad

1 : Enable

Forward and Reverse can be switch from keypad

b2 DC Braking

■ **b2-00 Zero Speed Holding (DC Braking) Start Frequency**

Sets the start frequency for Zero Speed Holding (DC braking). Enabled when b1-02 (Stopping Method Selection) is set to 0 (Ramp to Stop)

No.	Name	Setting Range	Default
b2-00	Zero Speed Holding (DC Braking) Start Frequency	0.0 to 10.0 Hz	0.5 Hz

This function operates differently according to the selected control method.

- Open-Loop V/F Control, Closed-Loop V/F Control, Open-Loop Vector Control (A1- 02 = 0, 1, 2) , PM Open-Loop Vector Control (A1- 02 = 4)

When the output frequency falls below the level set in this parameter, DC Braking is enabled for the time set to b2-03 (DC Braking Time at Stop).

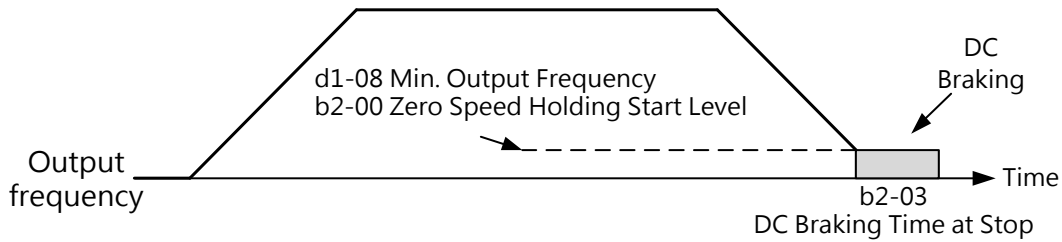

Figure 6.13 DC Braking Time at Stop

Note: When Zero Speed Holding Start Frequency (b2-00) is lower than Minimum Output Frequency (d1-08), Zero Speed Holding starts at Minimum Output Frequency (d1-08).

■ **b2-01 DC Braking Current**

Sets the DC braking current as a percentage of the drive rated current. When the current is set to more than 30%, the carrier frequency is automatically decreased to 1kHz.

No.	Name	Setting Range	Default
b2-01	DC Braking Current	0 to 100%	30%

The DC Braking current level affects the magnetic field strength to hold the motor shaft. The higher the current level is set, the higher amount of heat will be generated by the motor.

Therefore do not set this value higher than the level necessary to hold the motor shaft.

■ **b2- 02 DC Braking Time at Start**

Sets the DC braking time at start to stop a coasting motor before restarting it or to apply braking torque at start when a high starting torque is needed. Disabled when set to 0.00.

No.	Name	Setting Range	Default
b2-02	DC Braking Time at Start	0.00 to 99.99 s	0.00 s

Note: Attempting to run a coasting motor without using DC Braking or Speed Search may trigger oV (Overvoltage) or oC (Overcurrent) fault. Use DC Braking to stop the motor or use Speed Search to detect the motor speed before restarting it

■ **b2- 03 DC Braking Time at Stop**

Sets the DC braking time at stop to stop a motor rotating with high inertia. Disabled when set to 0.00.

No.	Name	Setting Range	Default
b2-03	DC Braking Time at Stop	0.00 to 99.99 s	0.5 s

b3 Speed Search

The Speed Search function is to detect the actual motor speed driven by the inertia and starting the motor operation from the current speed directly without a stop. When a momentary power loss shuts off the drive and causes motor to coast. Speed Search helps the drive to detect the speed of the coasting motor and restart directly.

The Speed Search method of the drive is current detection type. Follow the settings and instructions below.

■ **b3- 00 Speed Search Setting**

No.	Name	Setting Range	Default
b3-00	Speed Search Setting	0 to 2	0

0 : Disabled

1 : Enabled and searched from the highest frequency

2 : Enabled and searched from the frequency command

■ **b3- 01 Speed Search Operating Current**

Sets the current level as a percentage of the drive rated current below which Speed Search is deactivated. This parameter normally does not require any change. Lower this current level if the drive cannot restart the motor.

No.	Name	Setting Range	Default
b3-01	Speed Search Operating Current	0 to 100%	60%

- **b3- 02 Retain**

- **b3- 03 Speed Search Waiting Time**

No.	Name	Setting Range	Default
b3-03	Speed Search Waiting Time	0.0 to 100.0 s	0.2 s

b5 PID Control

PID control utilizes Proportional, Integral and Derivative Control to minimize the deviation between the PID target and feedback.

- **P Control**

P control outputs the proportion of P gain and the deviation linearly. With only P control, the deviation will not fall to 0.

- **I Control**

I control outputs the integral of the deviation. This minimizes the deviation between the PID target and feedback but not suitable for rapid load fluctuations.

- **D Control**

D control multiplies a time constant with deviation derivative (deviation slope) to predict the deviation, and then adds this value to the PID input. This utilizes derivative to control the braking and vibration.

D control tends to cause instability as the interference to deviation signal is larger. Use P control only when necessary.

- **PID Control Operation**

See the PID operation illustrated below how the P, I and D output frequency changes when the deviation between the PID target and feedback is constant.

- **PID Control Applications**

PID control can be used in the following applications.

Application	Description	Sensors Used
Speed Control	Adjusts the machinery speed to the target speed. Synchronizes the machinery speed from other machinery as the target speed.	Tachometer
Pressure	Feeds back pressure data to maintain constant pressure.	Pressure sensor

Control		
Fluid Control	Feeds back flow data to keep a constant flow level	Flow rate sensor
Temperature Control	Feeds back temperature data to maintain a constant temperature by control the fan speed.	Thermistor, thermocoupler

■ PID Target Input Methods

The PID target can be input according to the methods showed in Table 6.6. If more than one PID targets are input, it will be selected as per the priority.

Ex. When E3-01=9 (PID Target) and E5-00=2 (PID Target), the signal from terminal A1 will be selected as the PID target.

Table 6.6 PID Target Input Sources

Priority	PID Target Input Sources	Settings
Highest *	Terminal A1	Set E3-01 to 9 (PID target)
	Parameter b5-18	Set b5-17 to 1, and input the PID target to b5-18.
Lowest	Modbus Register	Set bit 1 in Modbus register 000FH to 1 (PID target input) and input the target to 0006H.

Note: When both terminal A1 and A2 are set to 9 (PID Target), oPE07 fault will be triggered.

■ PID Feedback Input Methods

There are two input methods. The first is to input one feedback signal for normal PID control. The second is to input two signals to control the deviation in between.

Normal PID Feedback:

Selects the PID feedback signal in the source listed in Table 6.7.

Table 6.7 PID Feedback Sources

PID Feedback Source	Setting
Terminal A1	Set E3-01 to 8 (PID feedback)

Note: When more than one PID feedback input source is assigned, oPE09 fault will be triggered.

■ PID Block Diagram

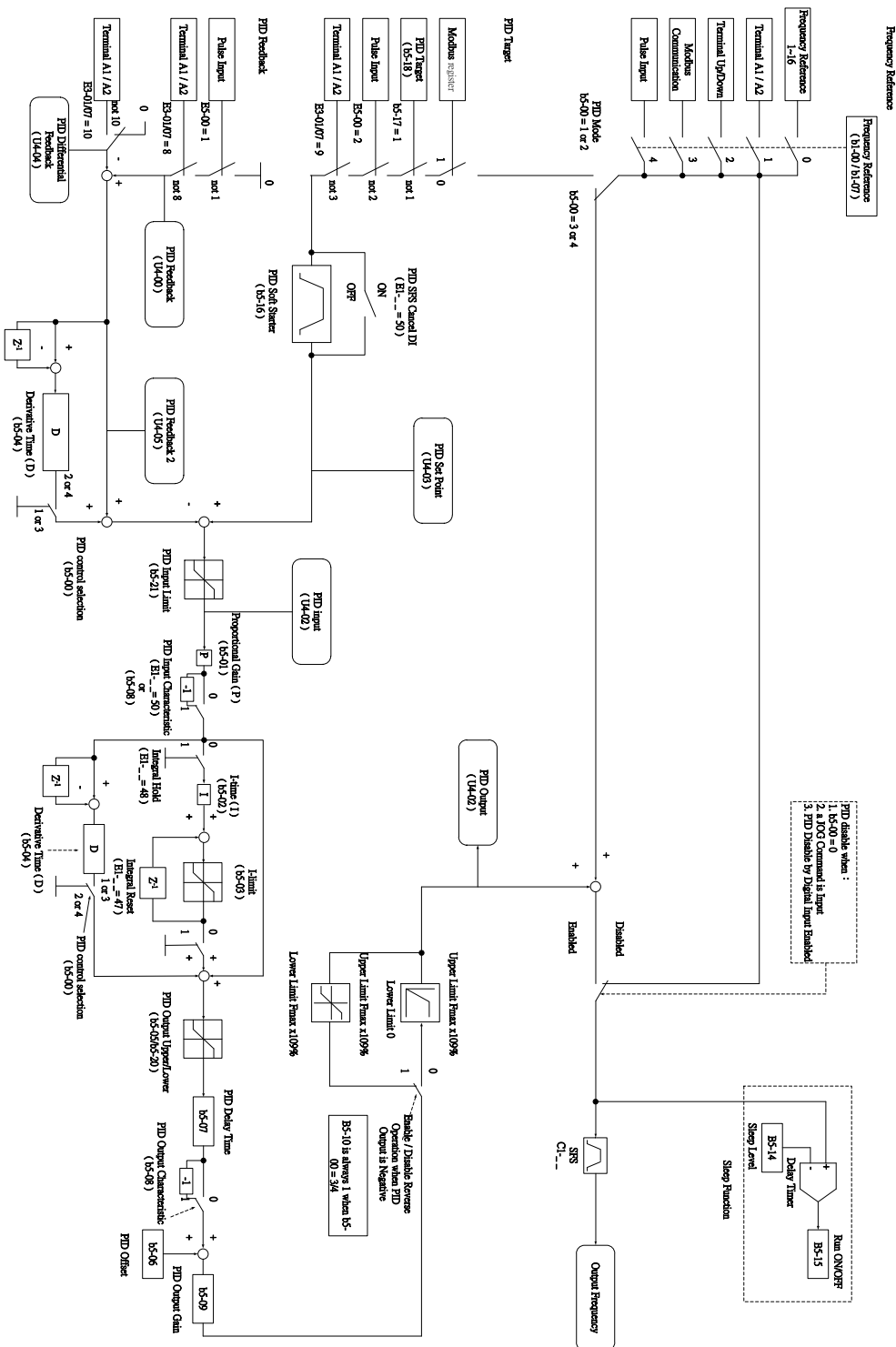

Figure 6.16 PID Block Diagram

■ **b5- 00 PID Control Setting**

Enables or disables the PID function and selects the PID mode.

No.	Name	Setting Range	Default
b5-00	PID Control Setting	0 to 4	0

0 : PID Control Disabled

1 : Output Frequency = PID Output 1

PID control is enabled. D (Derivative) control the deviation signal (U4-01) between the target and feedback as output frequency.

2 : Output Frequency = PID Output 2

PID control is enabled. D (Derivative) control the feedback signal (U4-05) as output frequency.

3 : Output Frequency = Frequency Command+ PID Output 1

PID control is enabled. D (Derivative) control the deviation signal (U4-01) between the target and feedback and add the frequency command as output frequency.

4 : Output Frequency = Frequency Command + PID Output 2

PID control is enabled. D (Derivative) control the feedback signal (U4-05) and add the frequency command as output frequency.

■ **b5- 01 Proportional Gain Setting (P)**

Sets the P gain for PID input.

The larger the P gain is set, the smaller the deviation will be, and vice versa. However vibration may occur if the value is set too high.

No.	Name	Setting Range	Default
b5-01	Proportional Gain Setting (P)	0.00 to 25.00	1.00

■ **b5- 02 Integral Time Setting (I)**

Deviation appears between PID target value and feedback value when using only proportional control. Set integral time (I) to reduce the deviation,.

Sets the time to calculate the integral of the PID input. The shorter the integral time is set, the faster the deviation will be eliminated, and vice versa. However vibration or overshoot may occur if the value is set too high. I control is disabled when b5-02=0.00.

No.	Name	Setting Range	Default
b5-02	Integral Time Setting (I)	0.0 to 360.0 s	1.0 s

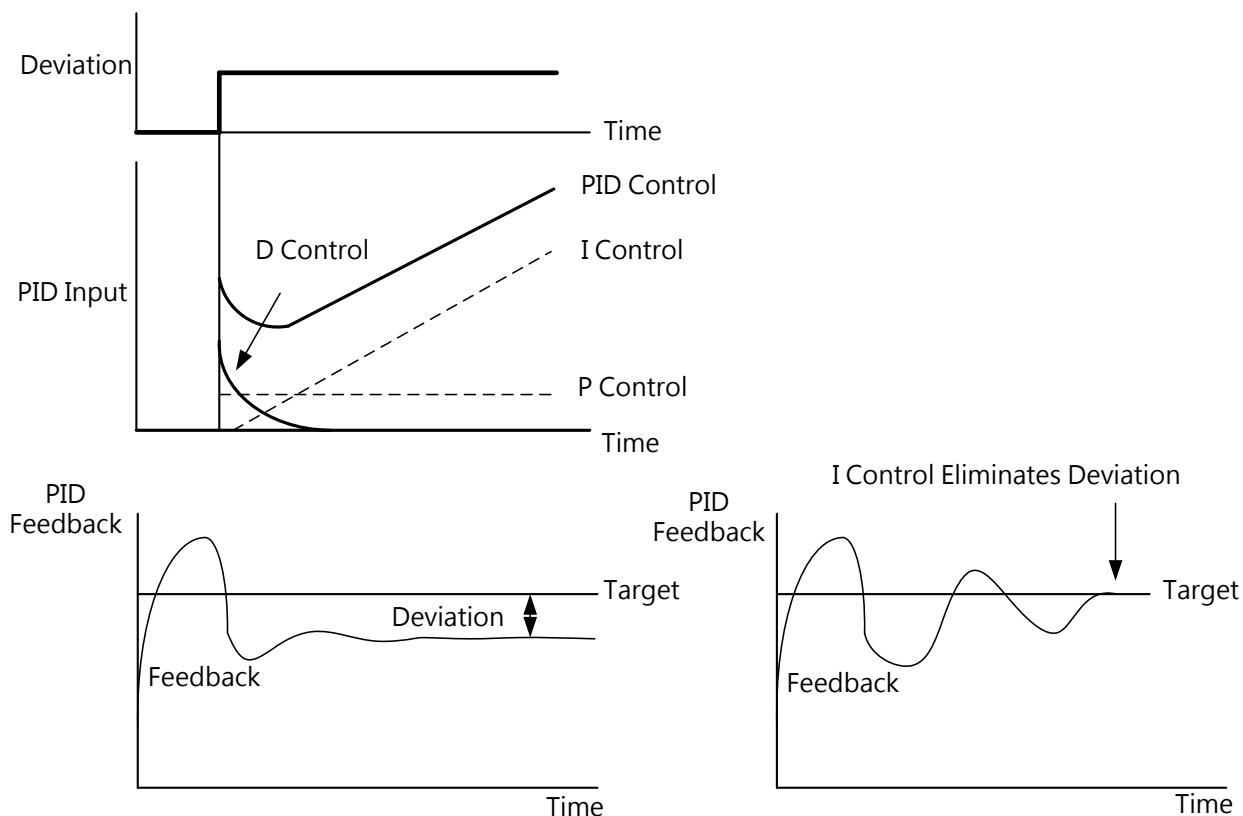

Figure 6.17 Relationship between Time and Deviation

■ **b5- 03 Integral Time (I) Limit Setting**

Sets the maximum output from the I (integral) control as a percentage of the maximum frequency (d1-02)

No.	Name	Setting Range	Default
b5-03	Integral Time (I) Limit Setting	0.0 to 100.0%	100.0%

Note: During rapid load fluctuations, PID output may show vibration. Set a limit to suppress the vibration so as to prevent the equipment damage or motor stall.

■ **b5- 04 Derivative Time (D)**

Set this parameter when response improvement is needed.

Sets the time to predict the deviation based on the derivative of the PID input and PID feedback.. The longer derivative time improves the response but may cause vibration as the shorter derivative time suppress the overshoot but decrease the response. D control is disabled when b5-04=0.00.

No.	Name	Setting Range	Default
b5-04	Derivative Time (D)	0.00 to 10.00 s	0.00 s

■ **b5- 05 PID Output Limit**

Sets the upper limit of output from PID control as a percentage of the maximum frequency.

No.	Name	Setting Range	Default
b5-05	PID Output Limit	0.0 to 100.0%	100.0%

■ b5- 06 PID Bias Voltage Adjustment

Sets the PID bias voltage adjustment as a percentage of the maximum frequency to add to the PID control output.

No.	Name	Setting Range	Default
b5-06	PID Bias Voltage Adjustment	-100.0 to 100.0%	0.0%

■ b5- 07 PID Primary Delay Time

Sets the delay time for the PID output filter. Change is normally not required.

No.	Name	Setting Range	Default
b5-07	PID Primary Delay Time	0.00 to 10.00 s	0.00 s

Note: This parameter is effective to avoid the vibration when abrasion is high and rigidity is low. Increasing this delay time could reduce the response of the drive.

■ b5- 08 PID Output Reverse

Reverses the +/- sign of the PID output. This is suitable for reverse acting applications as a positive PID target decrease the output frequency of the drive.

No.	Name	Setting Range	Default
b5-08	PID Output Reverse	0, 1	0

0 : Normal PID Output

A positive PID input causes an increase in the PID output.

1 : Reverse PID Output

A positive PID input causes an decrease in the PID output.

■ b5- 09 PID Output Gain

Sets a gain to multiply by the PID output. The compensation will be more effective when b5-00=3 or 4.

No.	Name	Setting Range	Default
b5-09	PID Output Gain	0.00 to 25.00	1.00

■ b5- 10 PID Output Reverse Selection

Determines whether or not a negative PID output reverses the drive rotating direction. This parameter is disabled when b5-00 =3 or 4, but the PID output will not be limited (same as

b5-27=1)

No.	Name	Setting Range	Default
b5-10	PID Output Reverse Selection	0, 1	0

0 : Reverse Disabled

Negative PID output will be limited to 0 and stop the drive.

1 : Reverse Enabled

The drive will run reversely if PID output is negative.

■ PID Feedback Low /High Detection

This detects whether the sensor or the sensor wiring is broken. Always use this function during PID control so as to avoid machinery accelerating to the maximum frequency cause by PID feedback low / high.

· PID Feedback Low

This will be detected when the value is lower than the set level for longer than the set time.

· PID Feedback High

This will be detected when the value is higher than the set level for longer than the set time.

The PID Feedback Low Detection operation is illustrated below. Same way applies to PID Feedback High Detection.

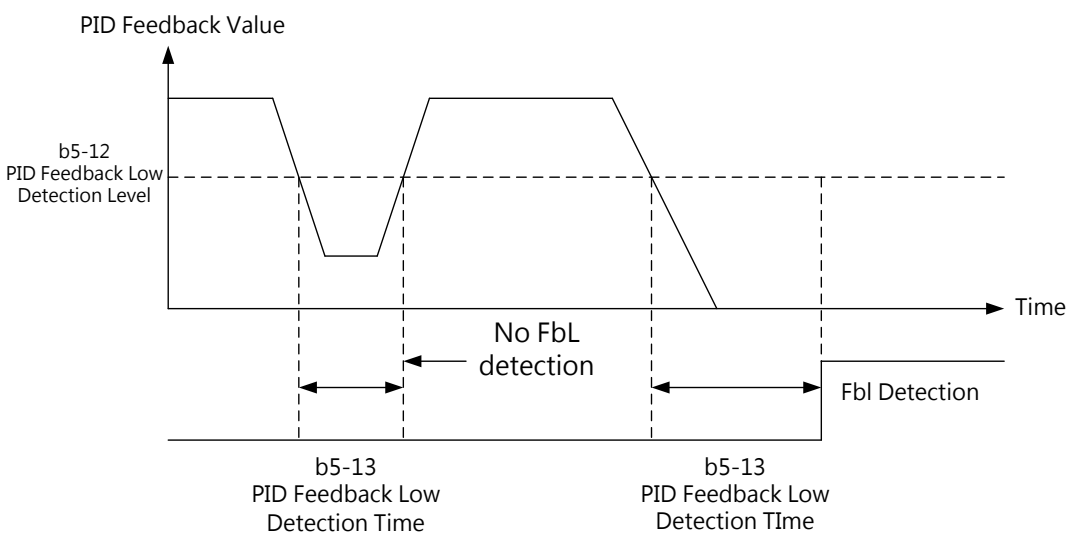

Figure 6.18 PID Feedback Low Detection

Set b5-11 to b5-13 for PID Feedback Low Detection, and b5-11, b5-22, b5-23 for PID Feedback

High Detection.

■ **b5- 11 PID Feedback Low /High Detection Selection**

Sets the feedback low /high detection and the operation when it is detected.

No.	Name	Setting Range	Default
b5-11	PID Feedback Low /High Detection Selection	0 to 5	0

0 : Multi-Function Output Only

A multi-function output set for E2-□□= 40 (PID feedback low) will be triggered if the PID feedback value is lower than the detection level set to b5-12 for longer than the detection time set to b5-13

A multi-function output set for E2-□□= 41 (PID feedback high) will be triggered if the PID feedback value is higher than the detection level set to b5-22 for longer than the detection time set to b5-23

No alarm or fault will be triggered. The drive will continue operation. The output resets when the PID feedback value returns to the normal range.

1 : Feedback Low /High Alarm

A FbL (PID feedback low) alarm and a multi-function output set for E2-□□= 40 (PID feedback low) will be triggered if the PID feedback value is lower than the detection level set to b5-12 for longer than the detection time set to b5-13, the keypad

A FbH (PID feedback high) alarm and a multi-function output set for E2-□□= 41 (PID feedback high) will be triggered if the PID feedback value is higher than the detection level set to b5-22 for longer than the detection time set to b5-23

A multi-function output set for E2-□□=13 (alarm) will be triggered in either event. The drive will continue operation. The alarm resets when the PID feedback value returns to the normal range.

2 : Feedback Low /High Fault

A FbL (PID feedback low) fault will be triggered if the PID feedback value is lower than the detection level set to b5-12 for longer than the detection time set to b5-13, the keypad

A FbH (PID feedback high) fault will be triggered if the PID feedback value is higher than the detection level set to b5-22 for longer than the detection time set to b5-23

A multi-function output set for E2-□□=11 (fault) will be triggered in either event to cause the drive to stop the motor.

3 : Multi-Function Output only, even if PID is Disabled

Same as b5-11= 0.

4 : Feedback Failure Alarm, even if PID is Disabled

Same action as b5-11=1.

5 : Feedback Failure Fault even if PID is Disabled

Same action as b5-11=2.

6 : Multi-Function Output, it continue to operate and light failure is not displayed

A feedback loss condition is detected when the PID feedback value falls below the value set in parameter b5-12 (PID feedback loss detection level) for the time set in parameter b5-13 (PID feedback loss detection time), E2- □□ = 40 terminal set is closed

A feedback loss condition is detected when the PID feedback value falls over the value set in parameter b5-22 (PID feedback loss detection level) for the time set in parameter b5-23 (PID feedback loss detection time), E2- □□ = 41 terminal set is closed

The inverter continues to operate. When the feedback value is not lost within the detection range, the output will be reset.

7 : Multi-Function Output Only (Detection of non-operation is still valid)

Function 7 with the function 0, the difference lies in the function 0 must detect valid in operation, function 7 in the non-operation effectively

■ **b5- 12 PID Feedback Low Detection Level**

Sets the PID feedback level used for detection. When the PID feedback falls below this level for longer than the time set to b5-13, PID feedback loss will be detected.

No.	Name	Setting Range	Default
b5-12	PID Feedback Low Detection Level	0 to 100%	0%

■ **b5- 13 PID Feedback Low Detection Time**

Sets the PID feedback time used for detection. When the PID feedback falls below the level set to b5-12 for longer than this time, PID feedback loss will be detected.

No.	Name	Setting Range	Default
b5-13	PID Feedback Low Detection Time	0.0 to 25.5 s	1.0 s

■ **PID Sleep**

PID Sleep will be triggered when the PID output or frequency command falls below the set level for longer than the set time. The drive will resume operation when the PID output or

frequency command exceeds the set level for longer than the set time.
 PID Sleep operation is illustrated below.

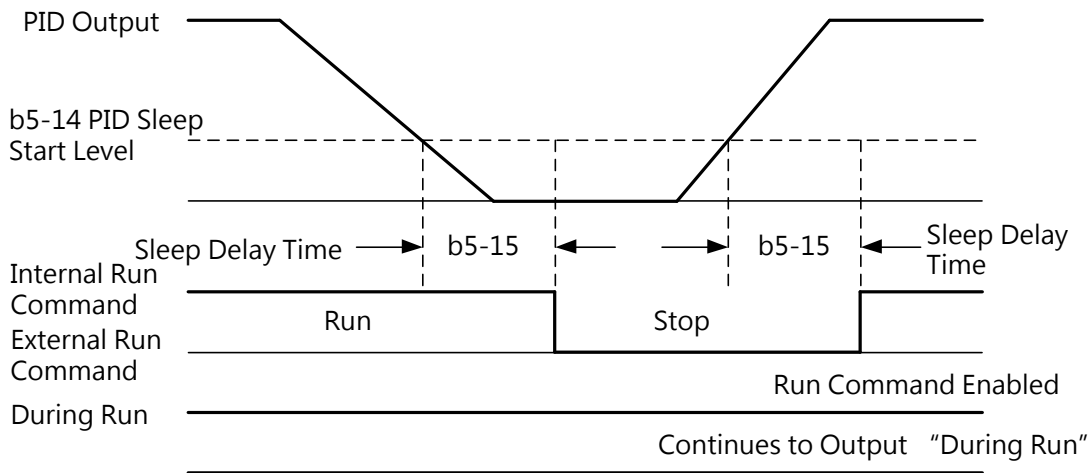

Figure 6.19 PID Sleep Operation

Notes for PID Sleep function

- The Stopping Method for PID Sleep function is determined by b1-02
- Set the PID Sleep function in b5-14 and b5-15.

■ **b5- 14 PID Sleep Start Level**

Sets the frequency level used to trigger PID Sleep.

PID Sleep will be triggered when the PID output or frequency command falls below the level set to b5-14 for the time longer than the time set to b5-15. The drive will resume operation when the PID output or frequency command exceeds the level set to b5-14 for longer than the time set in b5-15.

No.	Name	Setting Range	Default
b5-14	PID Sleep Start Level	0.0 Hz to <1>	0.0 Hz

<1> The upper limit is determined by the values set to d1-02 (Maximum Output Frequency), d1-13 (Motor 2 Maximum Output Frequency) and L2-00 (Frequency Command Upper Limit).

■ **b5- 15 PID Sleep Delay Time**

Sets the delay time used to activate/deactivate the PID Sleep function.

No.	Name	Setting Range	Default
b5-15	PID Sleep Delay Time	0.0 to 25.5 s	0.0 s

■ **b5- 16 PID Acc./Dec. Time**

The PID Acc. /Dec. time is used for the PID target.

When the PID target changes quickly, the normal C1-□□ Acc. time decreases the response

since it is applied after the PID output. This PID Acc./Dec. time prevents the overshoot, undershoot and hunting caused by the decreased response. In addition, set a lower value to parameter group C1 to avoid hunting. This parameter will be disabled if a multi-function input is assigned to E1-□□= 49 (PID Soft-Start On/Off).

No.	Name	Setting Range	Default
b5-16	PID Acc./Dec. Time	0.0 to 6000.0 s	0.0 s

■ b5- 17 PID Target Selection

Enables or disables b5-18 for PID target.

No.	Name	Setting Range	Default
b5-17	PID Target Selection	0, 1	0

0: PID Target Disabled

The value set to b5-18 is disabled.

1: PID Target Enabled

The value set to b5-18 is enabled.

■ b5- 18 PID Target Value

Sets the PID target value as a percentage of the maximum output frequency when b5-17 is set to 0

No.	Name	Setting Range	Default
b5-18	PID Target Value	0.00 to 100.00%	0.00%

■ b5- 19 PID Target Value Units

Sets the display units for b5-18, U4-00 (PID Feedback) and U4-03 (PID Target).

No.	Name	Setting Range	Default
b5-19	PID Target Value Units	0 to 3	1

0: 0.01Hz

Displays the PID target in 0.01 Hz units.

1: 0.01%

Displays the PID target as a percentage of maximum frequency.

2: r/min

Displays the PID target in r/min. Number of Motor Poles must be set

3 : User Defined

Displays the PID target in the units defined by b5-24 and b5-25

■ b5- 20 PID Output Lower Limit

Sets the minimum possible PID controller output as a percentage of the maximum output frequency (d1-02). The lower limit is disabled when set to 0.00%

No.	Name	Setting Range	Default
b5-20	PID Output Limit	-100.0 ~ 100.0%	0.0%

■ b5- 21 PID Input Limit

Sets the maximum allowed PID input as a percentage of the maximum output frequency (d1-02). Parameter b5-21 acts as a bipolar limit.

No.	Name	Setting Range	Default
b5-21	PID Input Limit	0.0 ~ 100.0%	100.0%

■ b5- 22 PID Feedback High Detection Level

Sets the level for PID feedback high detection as a percentage of the maximum output frequency.

PID feedback high will be detected when the feedback exceeds the level set in b5-22 for longer than the time set in b5-23.

No.	Name	Setting Range	Default
b5-22	PID Feedback High Detection Level	0 to 100%	100%

■ b5- 23 PID Feedback High Detection Time

Sets the time for PID feedback high detection. PID feedback high will be detected when the feedback exceeds the level set in b5-22 for longer than the time set in b5-23.

No.	Name	Setting Range	Default
b5-23	PID Feedback High Detection Time	0 to 25.5 s	1.0 s

■ b5- 24/b5- 25 PID Target Display Value/ PID Target Display Digits

When b5-19=3, b5-24 and b5-25 set a user-defined display for the PID feedback and target in U4-00 and U4-03. When b5-19≠3, parameters b5-24 and b5-25 cannot be edited.

b5-24 Sets the display value when run at the maximum frequency.

b5-25 Sets the number of decimal places to display..

No.	Name	Setting Range	Default
b5-24	PID Target Display Value	1 to 60000	0
b5-25	PID Target Display Digits	0 to 3	Determined by b5-19

0 : No Decimal Places

1 : 1 Decimal Place

2 : 2 Decimal Places

3 : 3 Decimal Places

■ **b5- 26 Frequency Reference Monitor Content During PID**

Sets the content of the frequency reference monitor display (U4-08) when PID control is active.

No.	Name	Setting Range	Default
b5-26	Frequency Reference Monitor Content During PID	0 、 1	0

0: Frequency Reference after PID

Monitor U4-08 displays the frequency reference increased or reduced for the PID output.

1: Frequency Reference

Monitor U4-08 displays the frequency reference value.

■ **b5- 27 PID Output Reverse Selection 2**

Determines whether a negative PID output reverses the direction of drive operation. When the PID function is used to trim the frequency reference (b5-00 = 3 or 4), this parameter has no effect and the PID output will not be limited °

No.	Name	Setting Range	Default
b5-27	PID Output Reverse Selection 2	0 、 1	1

Note : Set in b1-03 for the stop reverse, set b5-27 is ignored

0: Reverse Disabled

Negative PID output will be limited to 0 and the drive output will be stopped.

1: Reverse Enabled

Negative PID output will cause the drive to run in the opposite direction.

■ **b5- 28 PID Disconnection Output Frequency**

When a PID feedback disconnection alarm occurs(FbL), the drive will run at the frequency set to b5-28, and return to PID control when disconnection alarm is reset.

No.	Name	Setting Range	Default
b5-28	PID Disconnection Output Frequency	0.0 Hz to <1>	30.0 Hz

<1> The upper limit is determined by the values set to d1-02 (Maximum Output Frequency), d1-13 (Motor 2 Maximum Output Frequency) and L2-00 (Frequency Command Upper Limit).

■ PID Fine-Tuning

Follow the following instructions when the PID control parameters are set.

Overshoot Suppression

When an overshoot occurs, reduce the derivative time set to b5-04 and increase the integral time set to b5-02.

Stability after Overshoot.

To immediately achieve stability after an overshoot, increase the derivative time set to b5-04 and reduce the integral time set to b5-02.

Long Cycle Oscillation Suppression

If the oscillation cycle is longer than the integral time set to b5-02, increase the time as the integral operation is too strong.

Short Cycle Oscillation Suppression

If the oscillation cycle is almost the same as the derivative time set to b5-04, reduce the time as the derivative operation is too strong.

If even 0.00 derivative time (D control disabled) cannot suppress the oscillation, reduce the P Gain set to b5-01 or increase the PID Primary Delay Time set to b5-07.

■ b5- 28 PID Disconnection Output Frequency

When a PID feedback disconnection alarm occurs, the drive will run at the frequency set to b5-28, and return to PID control when disconnection alarm is reset.

No.	Name	Setting Range	Default
b5-28	PID Disconnection Output Frequency	0.0 Hz to <1>	30.0 Hz

<1> The upper limit is determined by the values set to d1-02 (Maximum Output Frequency), d1-13 (Motor 2 Maximum Output Frequency) and L2-00 (Frequency Command Upper Limit).

6.3 Group C, Tuning

C1 Acceleration and Deceleration Time

■ C1- 00 to C1- 03 Acceleration and Deceleration Times 1 to 4

Four different acceleration and deceleration times can be set in the drive by multi-function input terminals, motor selection or switched during run.

Set the acceleration time to determine the time needed to accelerate from 0Hz to the maximum frequency (d1-02). Set the deceleration time to determine the time needed to decelerate from the maximum frequency (d1-02) to 0Hz.

C1-00 and C1-01 are the active acceleration and deceleration times by default.

No.	Name	Setting Range	Default
C1-00	Acceleration Time 1	0.0 to 6000.0 s <1>	10.0 s
C1-01	Deceleration Time 1		
C1-02	Acceleration Time 2		
C1-03	Deceleration Time 2		

<1> The setting range of Acc./Dec is changed according to the setting of C1-09 (Acc./Dec. Time Unit Selection). When C1-09 = 0 (0.01 second), then the setting range is 0.00 to 600.00 (s).

□ Switching Acceleration Times by Multi-Function Input

C1-00 and C1-01 are the active acceleration and deceleration times by default. Enable C1-02 to C1-03 by E1-□□ (Multi-Function Digital Inputs)= 16 (Acc./Dec. Time Selection 1). Refer to Table 6.9.

Table 6.9 Acc./Dec. Times Selection by Multi-Function Input

Acc./Dec. Time Selection 1 E1-□□= 16	Active Times	
	Acceleration	Deceleration
0 (Open)	C1-00	C1-01
1 (Closed)	C1-02	C1-03

Figure 6.21 illustrates an operation example for changing acceleration and deceleration times. b1-02 (Stopping Method Selection) = 0 (Ramp to Stop).

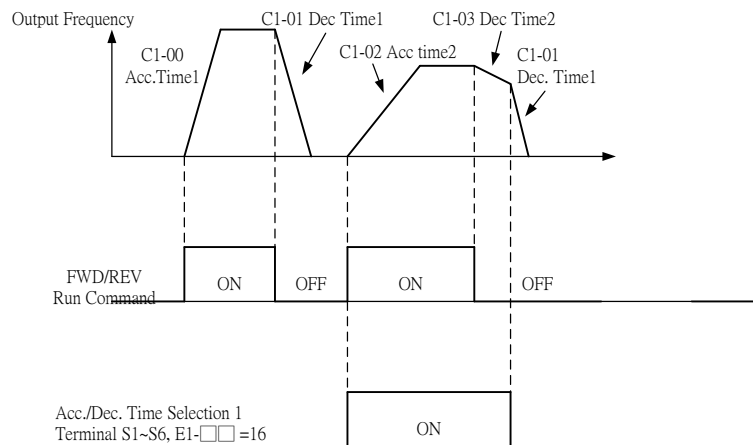

Figure 6.21 Operation of Acc./Dec. Time Change by Multi-Function Input

■ C1- 08 Fast Stop Time

Sets the deceleration time when E1-□□ = 21 (Fast Stop: Normal Open) or 22 (Fast Stop: Normal Closed). The input terminal does not have to be closed continuously to trigger Fast Stop. It will trigger Fast Stop even if the closure is momentary. Different from the normal deceleration, the drive cannot be restarted after entering Fast Stop until completing deceleration, remove the Fast Stop input and cycling the Run command.

If E2-□□ is set to 44 (During Fast Stop), this terminal will close during Fast Stop.

If Fast Stop is the action selected for a fault detection, the Fast Stop time set in this parameter will be the deceleration time.

No.	Name	Setting Range	Default
C1-08	Fast Stop Time	0.0 to 3600.0 s <1>	10.0 s

<1> The setting range is determined by the C1-09 (Acc./Dec. Time Unit Selection) setting. When C1-09 = 0, the setting range is 0.00 to 360.00 (second).

Note: A rapid deceleration will trigger an OVD fault and shut off the drive output causing the motor to coast. To avoid the motor coasting and to ensure the motor stops safely, always set an appropriate time to this parameter.

■ C1-11/ C1-12 Jog Frequency Acc. / Dec. Time

C1-11 sets the acceleration time from 0Hz to the Jog frequency command (L1-16). And C1-12 sets the deceleration time from the Jog frequency command (L1-16) to 0Hz.

No.	Name	Setting Range	Default
C1-11	Jog Frequency Acc. Time	0.0 to 6000.0 s <1>	10.0 s
C1-12	Jog Frequency Dec. Time		

<1> The setting range changes depending on the C1-09 setting. When C1-09 = 0 (Units of 0.01s), the range will be

0.00s to 600.00s.

C2 S-Curve Characteristics

Sets the S-curve characteristics to reduce the shock to the machinery at start and stop. Sets the S-curve characteristic time at the start and stop of acceleration and deceleration.

■ **C2- 00 to C2- 03 S-Curve Characteristic at Start/Stop of Acc./Dec.**

Sets the S-curve characteristic time in C2-00 to C2-03.

No.	Name	Setting Range	Default
C2-00	S-Curve Characteristic at Acc. Start	0.00 to 10.00 s	0.20 s
C2-01	S-Curve Characteristic at Acc. End		
C2-02	S-Curve Characteristic at Dec. Start		
C2-03	S-Curve Characteristic at Dec. End		

S-curve characteristics are illustrated below.

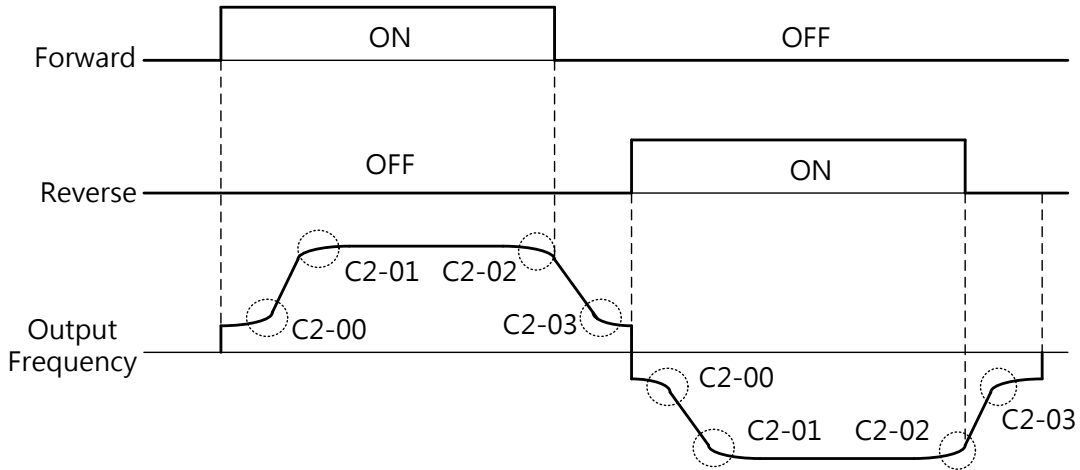

Figure 6.23 S-Curve Characteristics during Forward and Reverse

Setting the S-curve will increase the actual acceleration and deceleration times.

$$\text{Actual acceleration time} = \text{acceleration time setting} + (C2-00 + C2-01) / 2$$

$$\text{Actual deceleration time} = \text{deceleration time setting} + (C2-02 + C2-03) / 2$$

C3 Torque Compensation

The torque compensation is to enlarge the torque by increasing the output voltage when larger load is applied. The drive detects the increased amount of the load by the output current and adjusts the control with higher output voltage.

Note: Check if the motor parameters and the V/F pattern are set correctly before setting the torque compensation.

■ C3-00 Torque Compensation Gain

Sets the gain for the motor 1 Torque compensation.

No.	Name	Setting Range	Default
C3-00	Torque Compensation Gain	0.00 to 2.50	0

□ Torque Compensation in Closed-Loop and Open-Loop V/F Control

The drive calculates the voltage loss on the output side using the output voltage and the d2-04 (Motor Line-to-Line Resistance) value, and improves the torque when it is insufficient during start or running at low speed.

Compensation voltage = Motor primary voltage loss \times C3-00.

□ Torque Compensation in Sensorless Voltage Vector Control (SVVC)

The motor excitation currents d-axis and q-axis are controlled separately. Torque compensation affects q-axis current only.

Compensation voltage = q-axis voltage compensation (calculated by q-axis current) \times C3-00

Adjustment:

Normally there is no need to change this parameter setting. However, adjust this setting by scaling of 0.05 in the following situations.

- Increase the setting when using a long motor cable
- Decrease the setting when the motor oscillates
- During running at low speed, adjust C3-00 to keep the output current below the drive rated current

Note:

- Do not change the setting in Sensorless Voltage Vector Control as it will reduce the torque accuracy.

C5 Slip Compensation

The heavier the load is at IM motors, the slower the motor speed is. The Slip Compensation function can improve the speed accuracy in such situations.

Note: Check if the settings of d2-00 (Motor Rated Current), d2-01 (Motor Rated Slip) and d2-02 (Motor No-Load Current) are correct before adjusting this parameter. It is automatically set by Auto-Tuning in Open-Loop Vector Control.

■ C5- 00 Slip Compensation Gain

Sets the slip compensation gain to improve the speed accuracy for heavy loads. Normally there is no need to change this parameter. However, adjust the setting in the following situations.

- Increase the setting if the motor speed is lower than the frequency command.
- Decrease the setting if the motor speed is higher than the frequency command.

No.	Name	Setting Range	Default
C5-00	Slip Compensation Gain	0.0 to 2.5	0.0

Note: When A1-02 = 0 (Open-Loop V/F Control), the default setting is 0.0. When A1-02 = 1 (Open-Loop Vector Control), the default setting is 1.0.

■ C5- 01 Slip Compensation Primary Delay Time

Sets the slip compensation primary delay time to stabilize the motor speed or to improve the speed response. Normally there is no need to change this parameter. However, adjust the setting in the following situations.

- Decrease the setting if the slip compensation response is too slow.
- Increase the setting if the motor speed is unstable.

No.	Name	Setting Range	Default
C5-01	Slip Compensation Primary Delay Time	0 to 10000 ms	Determined by A1-02

Note: When A1-02 = 0 (Open-Loop V/F Control), the default setting is 2.000 s. When A1-02 = 1 (Open-Loop Vector Control), the default setting is 0.200 s.

C6 Carrier Frequency

■ C6-00 Carrier Frequency Selection

Sets the switching frequency of the drive output transistors. Adjust this setting to reduce audible noise and leakage current.

Note:

1. If this level is set higher than the default setting, the drive rated current will be decreased.

No.	Name	Setting Range	Default
C6-00	Carrier Frequency Selection	0 to 12	8

C6-00	Carrier Frequency	C6-00	Carrier Frequency	C6-00	Carrier Frequency
0	Determined by C6-01 to C6-03	6	6 kHz	12	12kHz
1	Retain	7	7 kHz		
2	2 kHz	8	8 kHz		
3	3 kHz	9	9 kHz		
4	4 kHz	10	10 kHz		
5	5 kHz	11	11 kHz		

Setting Carrier Frequency

Situation	Solution
Speed and torque fluctuate at low speeds	Lower the carrier frequency
The drive noise affects peripheral devices	
Excessive leakage current from the drive	
Cable connecting the drive and motor is too long<1>	
Loud noise from the motor	Increase the carrier frequency <2>

<1> If the cable is too long, lower the carrier frequency according to the follow instructions.

Cable Length	Less than 50 m	Less than 100 m	More than 100 m
C6-00	2 to 12 (excluding 12 kHz)	2 to 5	2

Note: In PM Open-Loop Vector ControlP (A1-02=5), make sure the cable connecting the drive and motor is less than 100 meters.

■ C6-01/ C6-02/ C6-03 Maximum / Minimum Carrier Frequency / Carrier Frequency Proportional Gain

Set 0 to parameter C6-00 to enable this setting. Sets the maximum and minimum carrier frequency in V/F Control that the drive will adjust carrier frequency according to the output

frequency.

No.	Name	Setting Range	Default
C6-01	Maximum Carrier Frequency	2.0 kHz to 12.0 kHz	Determined by C6-00
C6-02	Minimum Carrier Frequency	2.0 kHz to 12.0 kHz	
C6-03	Carrier Frequency Proportional Gain	0 to 99 <1>	

<1> This setting is only enabled when C6-00=0.

□ Setting a Fixed Carrier Frequency

C6-01 can be adjusted within the setting range when C6-00 is set to 0.

Set the same value in C6-01 and C6-02 in control methods other than V/F Control.

□ Setting a Variable Carrier Frequency (Only for V/F Control)

In V/F Control, the carrier frequency can be set up to change linearly with the output frequency by setting C6-01, C6-02 and C6-03 as shown in Figure 6.33.

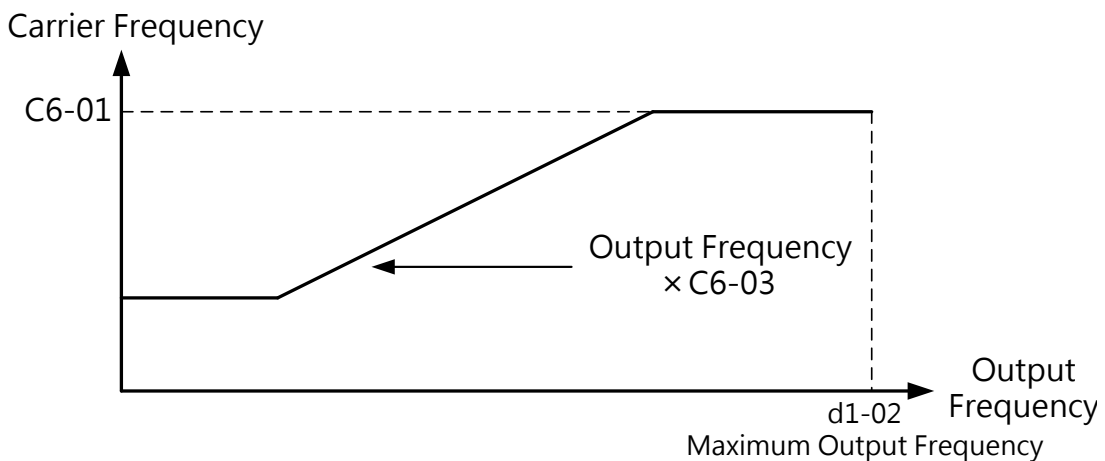

Figure 6.33 Carrier Frequency Changes Based on Output Frequency

Note:

1. When $C6-03 > 27$ and $C6-01 < C6-02$, the carrier frequency will be fixed to the value set to C6-01.
2. When $C6-03 < 7$, C6-02 is disabled and the carrier frequency will be fixed to the value set to C6-01.

■ C6-04 Retain

□ Carrier Frequency Changes Based on Rated Current

According to carrier frequency settings, the drive rated output current changes as shown in Table 6.11. The carrier frequency changes linearly with output current. Refer to Table 6.11 to calculate the value if it is not specified.

Table 6.11 Carrier Frequency Changes Based on Rated Current

Three Phase 400V Class				
Model	Rated Current (A)			
	2kHz	8kHz	10kHz	12kHz
440V 0.5HP (0.4kW)	1.5	1.5	13.5	14
440V 1HP (0.75kW)	2.5	2.5	2.2	2
440V 2HP (1.5kW)	4.2	4.2	3.8	3.4

■ C7-00 SVVC Porortional Gain

According to application feature to set this gain, if the load is heavy increase the value, and vice versa to reduce this value. Recommend to adjust 10% roughly and then adjust 1% minute.

No.	Name	Setting Range	Default
C7-00	Proportional Gain	0 to 100%	30%

6.4 Group L, Frequency Command

L1 Frequency Command

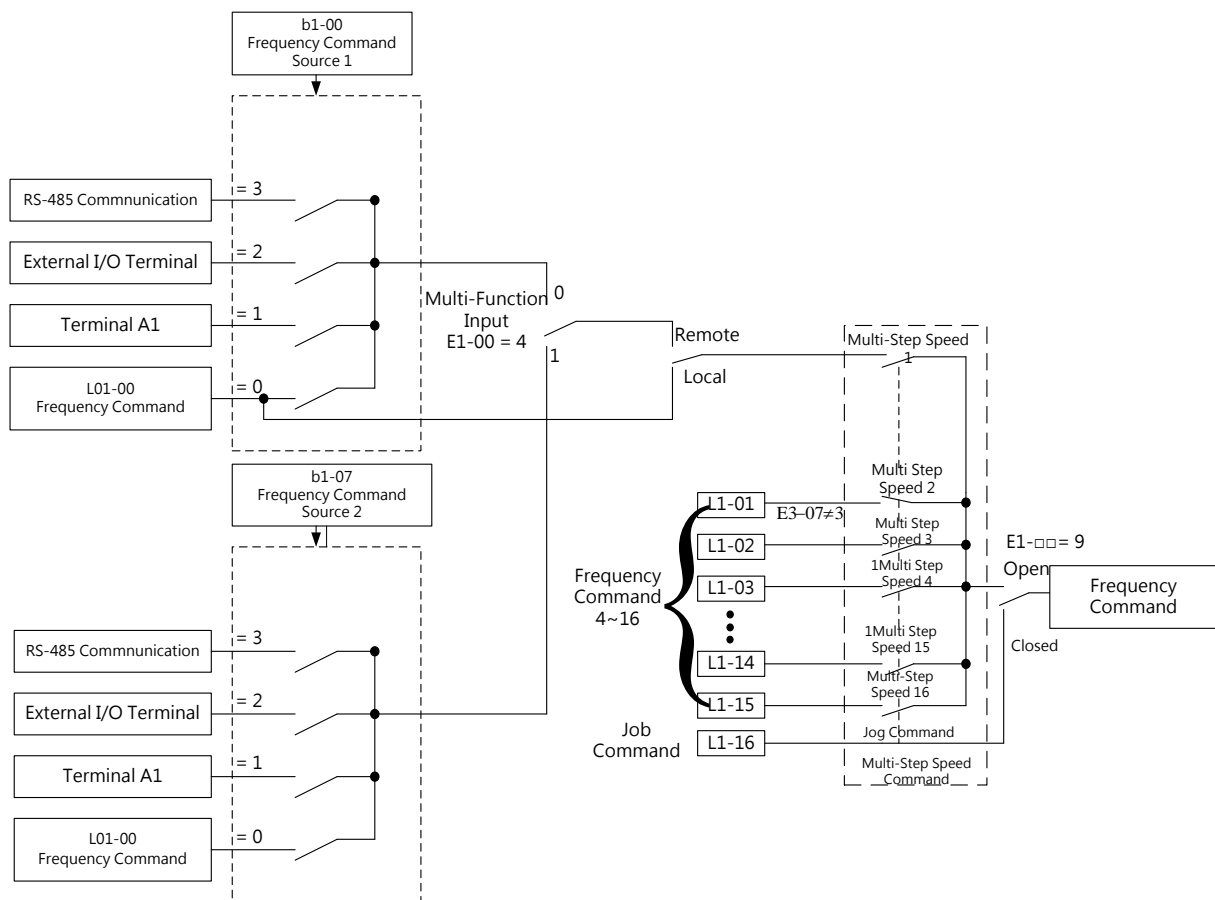

Figure 6.34 Frequency Command Diagram

■ L1-00 to L1-15 Frequency Command 1 to 16 and L1-16 Jog Frequency Command

The drive allows the user to switch between up to 16 frequency commands and 1 Jog frequency command. The drive uses the selected acceleration and deceleration times when switching between each frequency command.

The Job frequency command overrides frequency command 1 to 16.

No.	Name	Setting Range	Default
L1-00 to L1-15	Frequency Command 1 to 16	0.00Hz to <1> <2> <3>	L1-00 5.00Hz L1-01 8.00Hz L1-02 10.00Hz L1-03 12.00Hz L1-04 15.00Hz L1-05 20.00Hz L1-06 25.00Hz L1-07 30.00Hz L1-08 35.00Hz L1-09 40.00Hz L1-10 42.00Hz L1-11 45.00Hz L1-12 50.00Hz L1-13 50.00Hz L1-14 50.00Hz L1-15 50.00Hz
L1-16	Jog Frequency Command	0.00Hz to <1> <2> <3>	6.00 Hz <2>

<1> The upper limit is determined by d1-02 (Maximum Output Frequency) and L2-00 (Frequency Command Upper Limit).

<2> If L2-00 (Frequency Upper Limit) is adjusted, the excessive frequency in L1-00 to L1-15 will be automatically set to the upper limit determined in L2-00.

□ Setting Multi-Step Speed

To assign a multi-step speed command to a multi-function input, set E1-□□ = 5, 6, 7, 8 (Multi-Step Speed 1, 2, 3, 4). To assign the Jog frequency command to a multi-function input, set E1-□□ = 9.

Table 6.12 Multi-Step Speed Command and Multi-Function Terminal Combinations

Frequency Command	Multi-Step Speed Command 1 E1-□□=5	Multi-Step Speed Command 2 E1-□□=6	Multi-Step Speed Command 3 E1-□□=7	Multi-Step Speed Command 4 E1-□□=8	Multi-Step Speed Command 5 E1-□□=9

Frequency Command 1 (L1-00: set in b1-00)	OFF	OFF	OFF	OFF	OFF
Frequency Command 2 L1-01	ON	OFF	OFF	OFF	OFF
Frequency Command 3 L1-02	OFF	ON	OFF	OFF	OFF
Frequency Command 4 L1-03	ON	ON	OFF	OFF	OFF
Frequency Command 5 L1-04	OFF	OFF	ON	OFF	OFF
Frequency Command 6 L1-05	ON	OFF	ON	OFF	OFF
Frequency Command 7 L1-06	OFF	ON	ON	OFF	OFF
Frequency Command 8 L1-07	ON	ON	ON	OFF	OFF
Frequency Command 9 L1-08	OFF	OFF	OFF	ON	OFF
Frequency Command 10 L1-09	ON	OFF	OFF	ON	OFF
Frequency Command 11 L1-10	OFF	ON	OFF	ON	OFF
Frequency Command 12 L1-11	ON	ON	OFF	ON	OFF
Frequency Command 13 L1-12	OFF	OFF	ON	ON	OFF
Frequency Command 14 L1-13	ON	OFF	ON	ON	OFF
Frequency Command 15 L1-14	OFF	ON	ON	ON	OFF
Frequency Command 16 L1-15	ON	ON	ON	ON	OFF
Jog Frequency Command L1-16 <1>	-	-	-	-	ON

<1> The Job frequency command overrides frequency command 1 to 16.

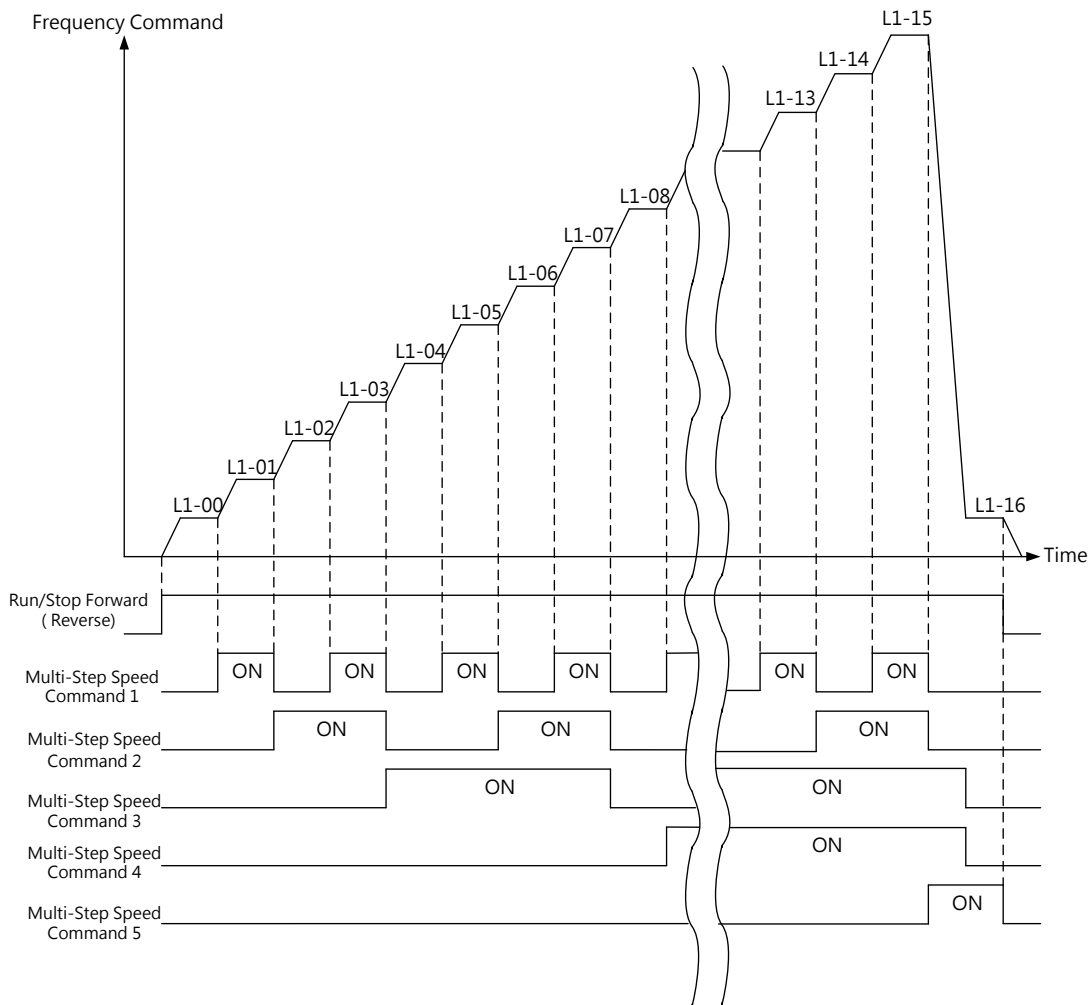

Figure 6.35 Jog Frequency Command Operation

L2 Frequency Upper / Lower Limit

Sets the upper and lower limits to make sure the motor runs in the range set to prevent resonance or machinery damage.

■ L2-00 Frequency Command Upper Limit

Sets the upper limit as a percentage of the maximum output frequency. Even if a frequency command higher than this level is entered, the drive will run at the limit set to this parameter.

No.	Name	Setting Range	Default
L2-00	Frequency Command Upper Limit	0.0 to 110.0 %	100.0 %

■ L2-01 Frequency Command Lower Limit

Sets the lower limit as a percentage of the maximum output frequency. Even if a frequency command lower than this level is entered, the drive will run at the limit set to this parameter.

No.	Name	Setting Range	Default
-----	------	---------------	---------

L2-01	Frequency Command Lower Limit	0.0 to 110.0%	0.0%
-------	-------------------------------	---------------	------

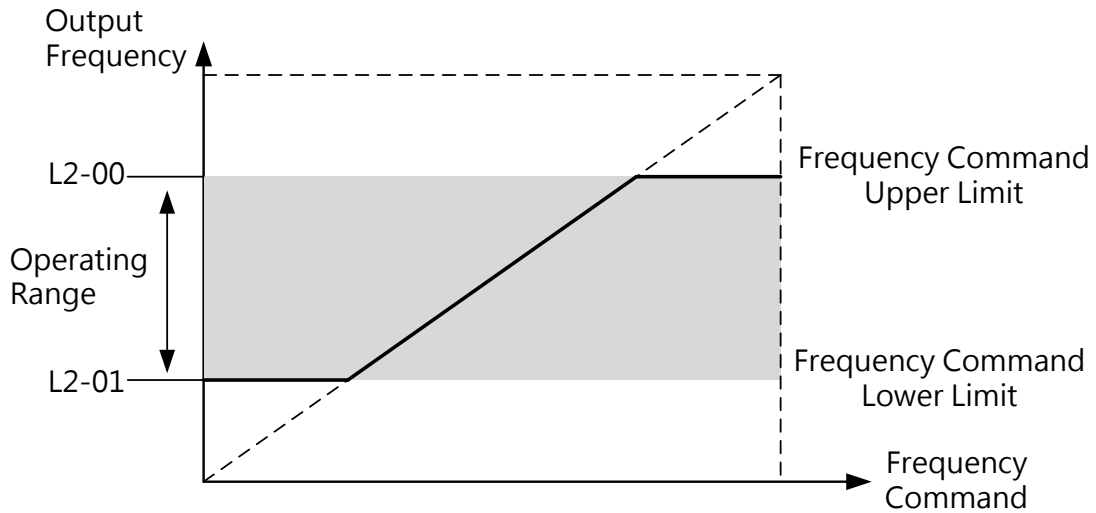

Figure 6.36 Frequency Command Upper and Lower Limits

L3 Jump Frequency

■ L3-00 to L3-03 Jump Frequency 1 to 2/ Jump Frequency Range

Sets the Jump frequency range to avoid operation at the speed causing resonance in the machinery. If the frequency command falls within a Jump frequency range, the drive will hold the frequency command at the upper limit of the range until accelerating past this range when the frequency command rises above that upper limit.

Sets L3-00 to L3-01 to 0.0 Hz to disable Jump frequency.

No.	Name	Setting Range	Default
L3-00	Jump Frequency 1	0.0 Hz to <1>	0.0 Hz <2>
L3-01	Jump Frequency 2		
L3-03	Jump Frequency Range	0.0 to d1-02 <3>	1.0 Hz <3>

<1> The upper limit is determined by the values set to d1-02 (Maximum Output Frequency).

The relationship between the output frequency and the Jump frequency is illustrated in the following figure.

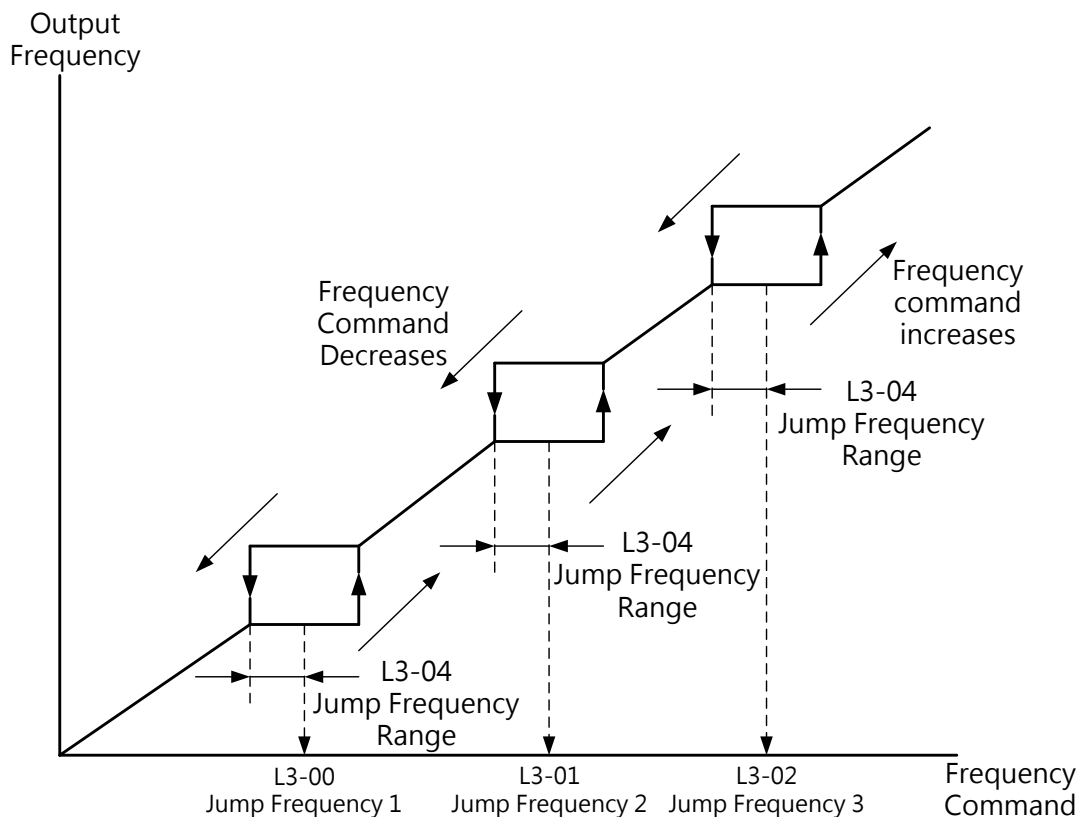

Figure 6.37 Jump Frequency Operation

Note:

1. The drive will not run at the frequency command or automatically change the frequency command within the Jump frequency range. The drive will smoothly run according to the acceleration and deceleration times C1-00 and C1-01.
2. When setting more than one Jump frequency, make sure $L3-00 \leq L3-01 \leq L3-02$.

L4 Up/Down 1, Up/Down 2 and Frequency Command Hold

■ L4-00 Up/Down Frequency Command Hold

This parameter is enabled in either of the following conditions.

- E1-□□ = 10/11 (Up/Down Command)
- E1-□□ = 12/13 (Up/Down 2 Command)

Determines whether or not to save the frequency command or the frequency bias (Up/Down 2) value when the Stop command is entered or the power supply is shut off.

No.	Name	Setting Range	Default
L4-00	Up/ Down Frequency Command Hold	0, 1, 2	0

0 : Clear Up/ Down Frequency Command at Stop

UP/DOWN commands via multi-function input terminals are enabled to adjust the speed only when the drive is running. The frequency command will be reset to 0 Hz when the Stop command is entered or the drive power supply is shut off.

1 : Save Up/ Down Frequency Command at Stop

UP/DOWN commands via multi-function input terminals are enabled to adjust the speed only when the drive is running. The frequency command will be saved to L4-03 when the Stop command is entered. The drive will follow the saved frequency command when restart. To reset the saved frequency command to 0, enter UP or Down before giving any Run command.

2 : Accept Up/ Down Frequency Command at Stop

UP/DOWN commands via multi-function input terminals are enabled to adjust the speed even when the drive is not running. The frequency command will be saved to L4-03 when the Stop command is entered. The drive will follow the saved frequency command when restart.

■ L4-01 Frequency Command Bias (Up 2 / Down 2)

Sets the bias used to add to or subtract from the frequency command by Up/Down 2.

No.	Name	Setting Range	Default
L4-01	Frequency Command Bias (Up 2 / Down 2)	0.00 to 99.99 Hz	0.00 Hz

The operation is determined by the set value.

Setting L4-01=0.00 Hz

When the Up 2 or Down 2 command is enabled, the bias value is increased or decreased using the acceleration and deceleration times defined by L4-02 (Frequency Command Acc./Dec Setting) and the acceleration and deceleration times set in C1-00 to C1-03 will be overridden.

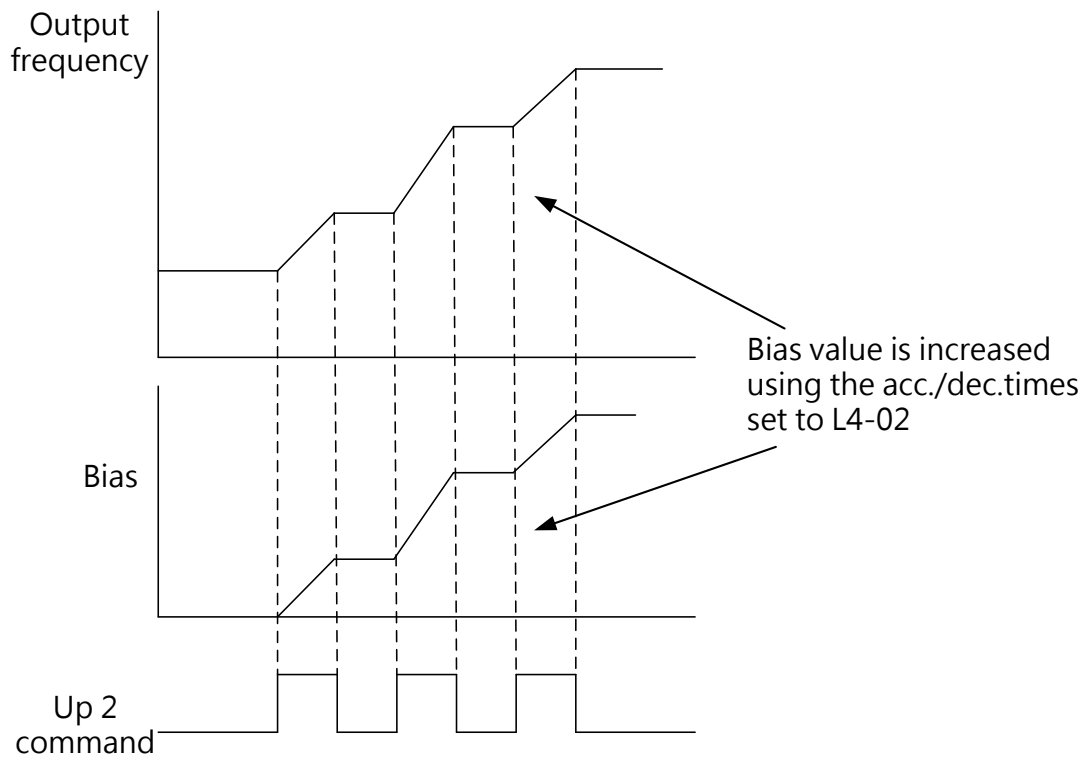

Figure 6.38 Up 2/Down 2 Bias when L4-01=0.0 Hz

Setting L4-01 \neq 0.00 Hz

If the Up 2 or Down 2 command is closed for less than 2 seconds, the bias is increased or decreased using the acceleration and deceleration times defined by L4-01 (Frequency Command Bias). If the Up 2 or Down 2 command is closed for more than 2 seconds, the bias is increased or decreased using the acceleration and deceleration times as Up 1/ Down 1. The frequency command changes with the acceleration and deceleration times defined by L4-02 (Frequency Command Acc./Dec Setting).

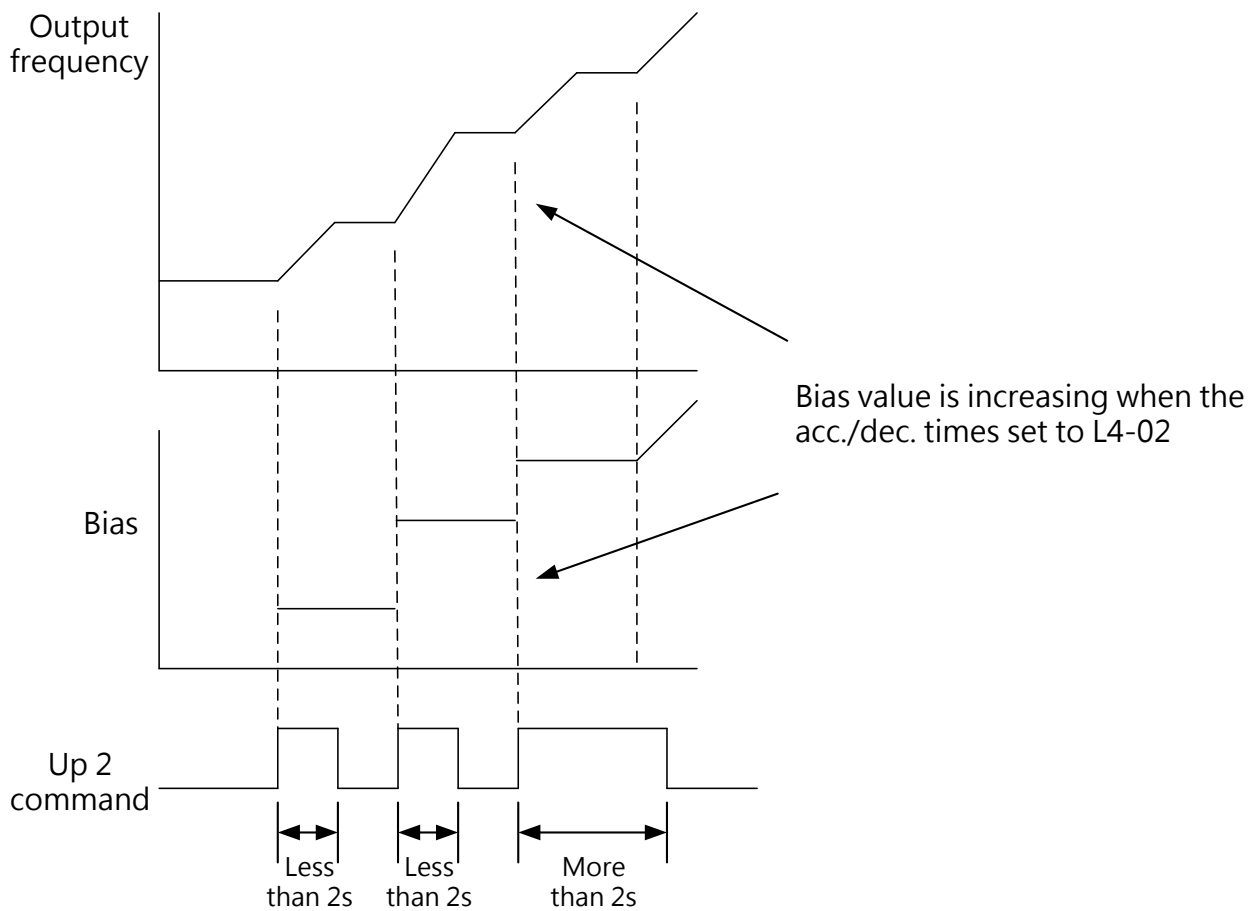

Figure 6.39 Up 2/Down 2 Bias when L4-01 > 0.0 Hz

■ **L4-02 Frequency Command Acc./Dec Setting (Up / Down 2)**

Sets the acceleration/deceleration times to increase or decrease the frequency command bias for Up/Down 2.

No.	Name	Setting Range	Default
L4-02	Frequency Command Acc./Dec Setting (Up2 / Down 2)	0, 1	0

0 : Current Acc./Dec. Time

The drive uses the currently active acceleration or deceleration time.

1 : Not chosen Acc./Dec. Time

■ **L4-03 Up/Down Frequency Command Save**

No.	Name	Setting Range	Default
L4-03	Up/Down Frequency Command Save	0.00 to 400.0	0.00 Hz

Saves the frequency command from Up/Down 1 or Up/Down 2. Up/Down 1 and Up/Down 2 cannot be used at the same time. If a multi-function input terminal is assigned to Up/Down 1 and Up/Down 2, an alarm will be triggered.

This parameter is enabled in the following situations.

1. b1-00 (Frequency Command Selection 1) or b1-07 (Frequency Command Selection 2)=2 (Terminal Up/ Down)
2. E1-□□= 10/11 (Up/Down Command) or E1-□□= 12/13 (Up/Down 2 Command)
3. L4-00 (Frequency Command Hold)= 1 or 2 (Enabled)

The Up/Down Frequency Command Save can also be given when a Stop command is entered.

■ L4-04 Frequency Command Hold

This parameter is enabled when any multi-function terminal is assigned to E1-□□= 18 (Acc./Dec. Ramp Hold)

Determines whether or not to save the frequency command when the Stop command is entered or the power supply is shut off.

No.	Name	Setting Range	Default
L4-04	Frequency Command Hold	0, 1	0

0 : Disabled

The frequency command will be reset to 0 Hz when the Stop command is entered or the drive power supply is shut off. The active frequency command will be the drive uses when the drive restarts.

1 : Enabled

The frequency command will be saved when the Run command is removed, and remain active when the drive restarts. However if the input terminal assigned to E1-□□= 18 is open when applying the power supply, the saved frequency command will be reset to 0 Hz.

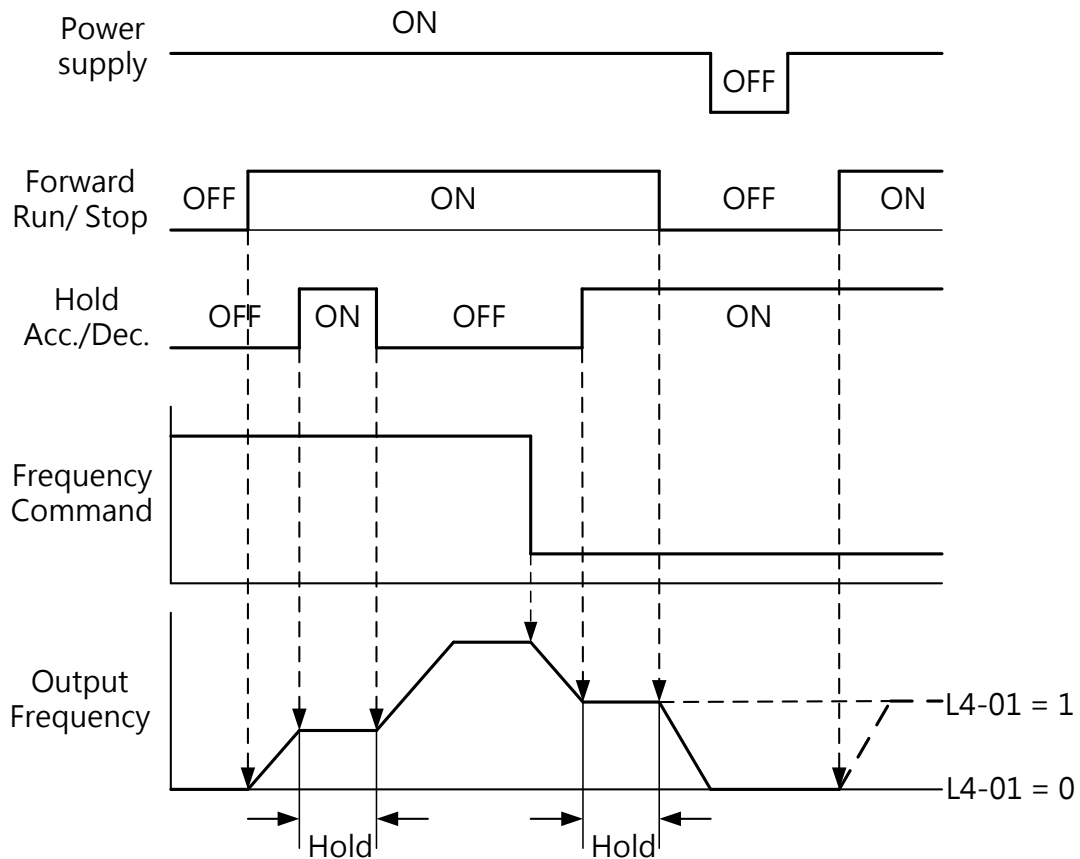

Figure 6.40 Frequency Command Hold with Acc./Dec. Hold

L6 Offset Frequency

■ L6-00 to L6-02 Offset Frequency 1 to 3

Sets the offset value as a percentage of the maximum output frequency to add to or subtract from the frequency command. Select the offset frequency in E1-□□= 53, 54 and 55 (Offset Frequency 1 to 3). The offset frequency will not add up being minus value and run in a reverse direction as it is limited by the upper and lower limit.

No.	Name	Setting Range	Default
L6-00	Offset Frequency 1	-100.0 to 100.0%	0.0%
L6-01	Offset Frequency 2	-100.0 to 100.0%	0.0%
L6-02	Offset Frequency 3	-100.0 to 100.0%	0.0%

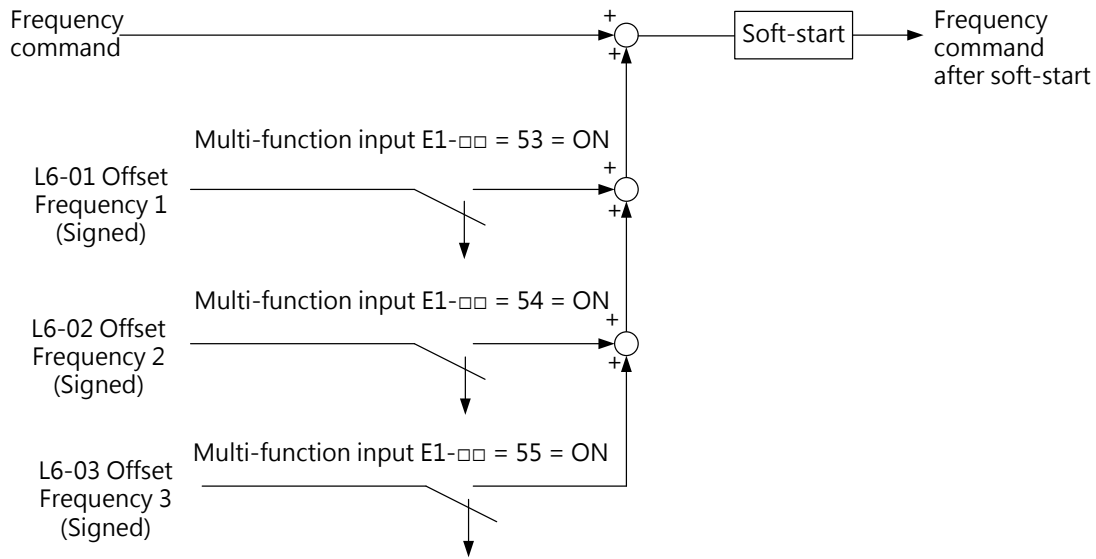

Figure 6.41 Offset Frequency Operation

6.5 Group d, Motor Parameters

d parameters set the V/F characteristics and motor parameters.

d1 V/F Characteristics

■ d1- 00 Input Voltage Setting

Sets this parameter to match the input voltage of the drive as the base for detections such as ov (Overvoltage) and Uv (Undervoltage).

Notice: To ensure the drive protection functions work properly, always set the input voltage of the drive (not motor) to this parameter. Failure to comply could cause damage to the machinery or injury to personnel.

No.	Name	Setting Range	Default
d1-00<1>	Input Voltage Setting	155 to 255 V <1>	200 V <1>

<1> This is for a 200 V AC drive. The value is doubled for a 400 V AC drive.

□ Values Related to Drive Input Voltage

The following detection levels are determined by the drive input voltage.

Voltage	d1-00 setting	Approximate Values			
		ov Detection Level	P7-13 (Dymanic Braking Level) <1>	P2-03 (UV Detection Level)	P3-04 (Stall Prevention Level during Deceleration)
200 V	All settings	410 V	395 V	190 V	395

400 V	Setting ≥ 400 V	820 V	790 V	380 V	790
	Setting < 400 V	820 V	790 V	350 V	790

<1> The braking transistor operation level.

■ V/F Pattern Setting(d1-01)

The set V/F pattern determines the output voltage according to the frequency command. There are 15 different preset V/F patterns (setting 0 to E: only the maximum voltage and base voltage can be changed) and user-defined V/F patterns d1-02 to d1-11 (setting F).

■ d1- 01 V/F Pattern Selection

Selects 1 V/F pattern from the preset 15 ones or sets the user-defined V/F pattern.

No.	Name	Setting Range	Default
d1-01	V/F Pattern Selection	0 to F <1>	F <2>

<1> This will not be reset by A1-03 (Reset).

<2> In Vector Control, d1-01 =F.

□ Preset V/F Pattern Selection (Setting Value 0 to E)

The preset V/F patterns are listed in Table 6.13. Select the appropriate V/F pattern and set to this parameter. d1-02 to d1-11 cannot be edited.

Note:

1. An improper V/F could cause motor undertorque or increased current because of overexcitation.
2. d1-01 will not be reset by A1-03 (Reset).

Table 6.13 V/F Pattern Selection

Setting Value	Selections	Characteristic	Applications
0	50 Hz	Constant Torque	For general purpose applications such as conveyors. The torque remains constant regardless of the speed.
1	60 Hz		
2	60 Hz (with 50 Hz base)		
3	72 Hz (with 60 Hz base)		
4	50 Hz, cube of derate	Derated Torque	For applications such as fans, pumps and other derated loads.
5	50 Hz, square of derate		
6	60 Hz, cube of derate		
7	60 Hz, square of derate		
8	50 Hz, mid starting torque	High Starting Torque	· Long wiring between the drive and motor (more than 150 m)
9	50 Hz, high starting torque		

A	60 Hz, mid starting torque		<ul style="list-style-type: none"> · Large starting torque is required such as elevators. · AC reactor is installed on the drive output side
B	60 Hz, high starting torque		
C	90 Hz (with 60 Hz base)	Fixed Output	Constant output voltage when running at 60 Hz and above.
D	120 Hz (with 60 Hz base)		
E	180 Hz (with 60 Hz base)		

The characteristics of the V/F patterns are illustrated in the following table. The table shows the V/F patterns for 200V. The voltage will be doubled for 400V.

Table 6.14 Constant Torque Characteristics (Setting 0 to 3)

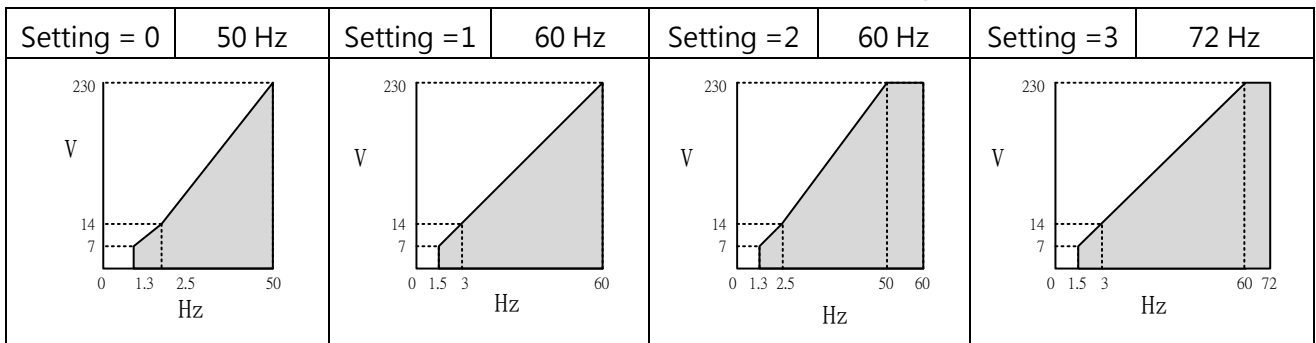

Table 6.15 Derated Torque Characteristics (Setting 4 to 7)

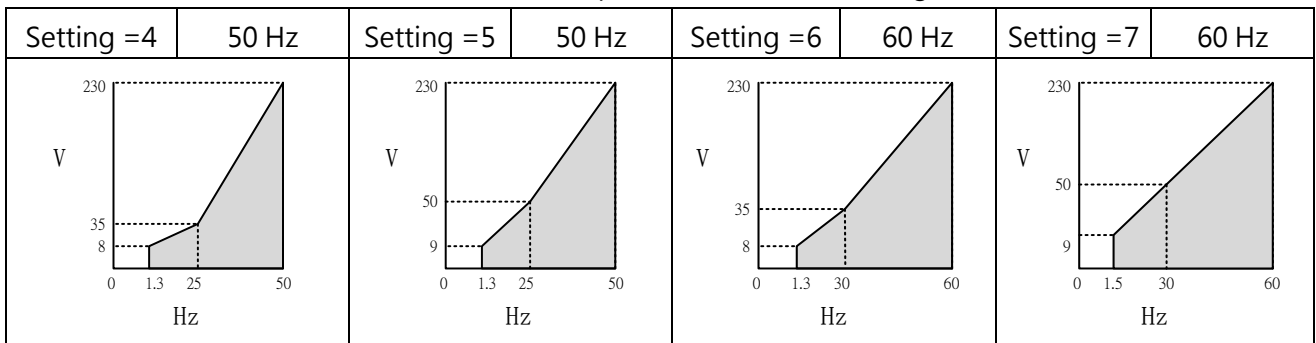

Table 6.16 High Starting Torque Characteristics (Setting 8 to B)

Setting = 8	50 Hz	Setting = 9	50 Hz	Setting = A	60 Hz	Setting = B	60 Hz
-------------	-------	-------------	-------	-------------	-------	-------------	-------

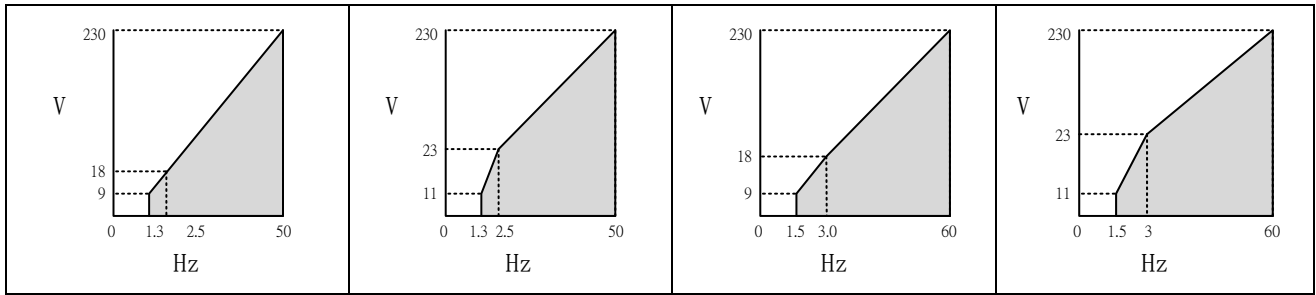
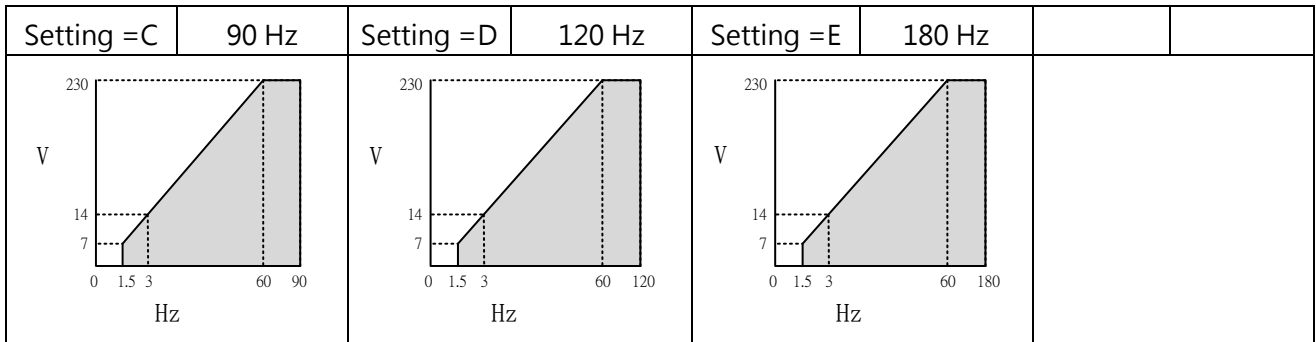

Table 6.17 Fixed Output Characteristics (Setting C to F)



User-Defined V/F Patterns (Default : F)

When d1-01 = F, d1-02 to d1-11 can be set to create a new pattern. d1-02 to d1-11 will be same as V/F pattern setting 1 after reset.

■ V/F Pattern Settings d1- 02 to d1- 09

When d1-01 ≤ E, the user can use d1-02 to d1-09 to monitor the V/F pattern settings. When d1-01 = F, d1-02 to d1-09 can be set to create a new pattern as shown in Figure 6.42.

No.	Name	Setting Range	Default
d1-02	Maximum Output Frequency	25.0 to 400.0 Hz	<1>
d1-03	Maximum Voltage	0.0 to 255.0 V <3>	<1> <2>
d1-04	Base Frequency	0.0 to d1-02	<1>
d1-05	Base Voltage	0.0 to 255.0 V <3>	0.0 V <2> <3>
d1-06	Middle Output Frequency	0.0 to d1-02	<1>
d1-07	Middle Output Voltage	0.0 to 255.0 V <3>	<1> <2>
d1-08	Minimum Output Frequency	0.0 to d1-02	<1>
d1-09	Minimum Output Voltage	0.0 to 255.0 V <3>	<1> <2>

<1> The default setting is determined by A1-02 (Control Method Selection). The settings in this table are the default in Open-Loop V/F Control.

<2> This is the value for a 200 V AC drive. The value for a 400 V AC drive is doubled.

<3> This will be automatically changed in Auto-Tuning (rotational, stationary 1 or 2).

<4> d1-10 and d1-11 will be disabled when setting 0.0.

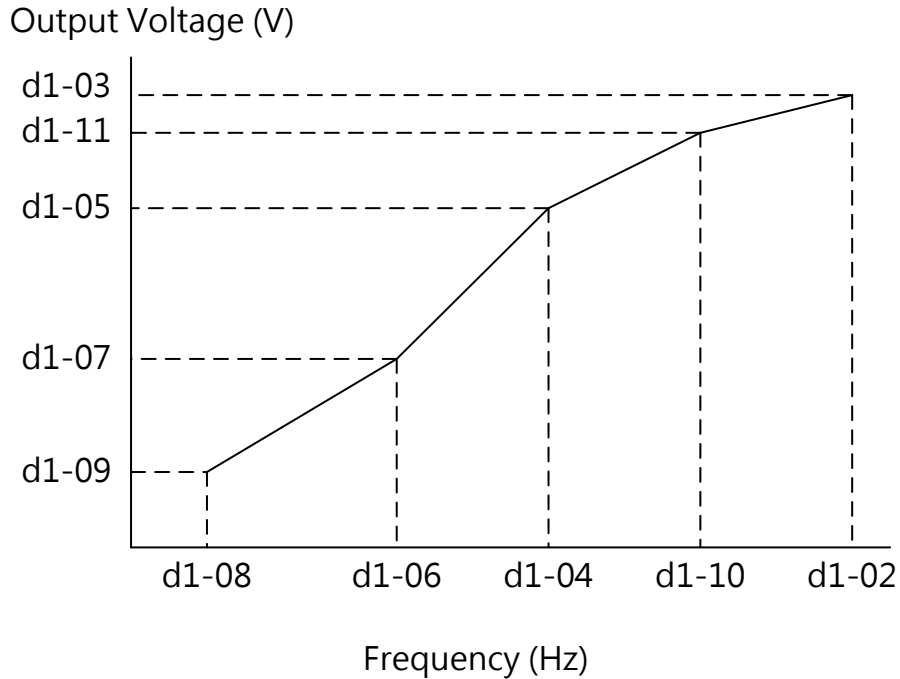

Figure 6.42 V/F Pattern

Note: When setting an user-defined V/F pattern, make sure $d1-08 \leq d1-06 < d1-04 \leq d1-10 \leq d1-02$.

d2 Motor Parameters

d2 parameters set the important motor information required to perform optimum motor control. In open-loop control methods, the motor parameters will be set automatically during Auto-Tuning. If Auto-Tuning cannot be performed properly, set the parameters manually.

■ d2- 00 Motor Rated Current

Sets the motor rated current according to the motor nameplate. This value determines the motor protection for torque and will be set automatically during Auto-Tuning.

No.	Name	Setting Range	Default
d2-00	Motor Rated Current	10 to 200% of drive rated current	Determined by o2-03,

Note:

1. It will be displayed in units of 0.1A.
2. If the d2-00 (Motor Rated Current) setting is lower than the d2-02 (Motor No-Load Current) setting, an oE02 (Parameter Range Setting Error) error will be triggered . Therefore properly set d2-02.

■ d2- 01 Motor Rated Slip

Sets the motor rated slip. This value determines the slip compensation and will be set automatically during Auto-Tuning.

No.	Name	Setting Range	Default
d2-01	Motor Rated Slip	0.00 to 20.00 Hz	Determined by o2-03

If Auto-Tuning cannot be performed, use the information shown on the motor nameplate to calculate the motor rated slip by the following formula.

$$d2-01 = f - (n \cdot p) / 120$$

f : rated frequency (Hz), n : motor rated speed (min⁻¹), p : number of motor poles

■ d2- 02 Motor No-Load Current

Sets the motor no-load current when running at no-load voltage and rated frequency. This will be set automatically during Auto-Tuning. This can also be set according to the no-load current listed on the motor test report. Contact the motor manufacturer for a test report.

No.	Name	Setting Range	Default
d2-02	Motor No-Load Current	0.0 A to [d2-00] A (exclude d2-00)	Determined by o2-03

■ d2- 03 Number of Motor Poles

Sets the number of motor poles. This will be set automatically during Auto-Tuning.

No.	Name	Setting Range	Default
d2-03	Number of Motor Poles	2 to 48	4

■ d2- 04 Motor Line-to-Line Resistance

Sets the line-to-line resistance. This will be set automatically during Auto-Tuning.

If Auto-Tuning cannot be performed, contact the motor manufacturer for the test report. Use the line-to-line resistance listed in the test report to calculate the line-to-line resistance by the following formula.

- E-type insulation: the resistance value (Ω) listed on the test report at 75°C × 0.92
- B-type insulation: the resistance value (Ω) listed on the test report at 75°C × 0.92
- F-type insulation: the resistance value (Ω) listed on the test report at 115°C × 0.87

No.	Name	Setting Range	Default
d2-04	Motor Line-to-Line Resistance	0.000 to 65.00 Ω <1>	Determined by o2-03

■ d2- 05 Motor Leakage Inductance

Sets the voltage drop caused by the motor leakage inductance relative to the motor rated frequency and current. This will be set automatically during Auto-Tuning.

No.	Name	Setting Range	Default
d2-05	Motor Leakage Inductance	0.00 to 650.0 mH	Determined by o2-03

■ **d2- 06 Motor Rotor Resistance**

Sets the motor rotor resistance. This will be set automatically during Auto-Tuning.

No.	Name	Setting Range	Default
d2-06	Motor Rotor Resistance	0.000 to 65.00 Ω <1>	Determined by o2-03

■ **d2- 07 Motor Mutual Inductance**

Sets the motor mutual inductance. This will be set automatically during Auto-Tuning.

No.	Name	Setting Range	Default
d2-07	Motor Mutual Inductance	0.0 to 6500 mH	Determined by o2-03

■ **d2- 08 Retain**

■ **d2- 09 Retain**

■ **d2- 10 Motor Rated Capacity**

Sets the motor rated capacity in units of 0.01kW. This will be set automatically during Auto-Tuning.

No.	Name	Setting Range	Default
d2-10	Motor Rated Capacity	0.00 to 650.0 kW	Determined by o2-03

Note: If the maximum motor capacity the drive can run is less than 300kW, it will be displayed in units of 0.01kW. If the maximum motor capacity the drive can run is more than 300kW, it will be displayed in units of 0.1kW. The maximum motor capacity the drive can run is determined by A1-06 (ND/HD Mode). Refer to Ch 2.4 on page 15 ?

■ **Motor Parameters Manual Setting**

Use the information listed on the motor test report and follow the instructions below.

□ **Motor Rated Current Setting**

Enter the rated current written on the motor nameplate to d2-00.

□ **Motor Rated Slip Setting**

Use the rated speed written on the motor nameplate to calculate the motor rated slip and set to d2-01.

Motor rated slip = motor rated frequency [Hz]- rated speed (min⁻¹)×number of motor poles / 120

□ Motor No-Load Current Setting

Sets the motor no-load current when running at no-load voltage and rated frequency. This information is not written on the motor nameplate. Contact the motor manufacturer for the information.

□ Number of Motor Poles Setting

d2-03 is only enabled in Closed-Loop V/F Control and Closed-Loop Vector Control. Enter the number of motor poles written on the motor nameplate.

□ Motor Line-To-Line Resistance Setting

d2-04 will be set automatically during Auto-Tuning. However if Auto-Tuning cannot be performed, contact the motor manufacturer for the test report. Use the line-to-line resistance listed in the test report to calculate the line-to-line resistance by the following formula.

- E-type insulation: the resistance value (Ω) listed on the test report at 75°C \times 0.92
- B-type insulation: the resistance value (Ω) listed on the test report at 75°C \times 0.92
- F-type insulation: the resistance value (Ω) listed on the test report at 115°C \times 0.87

□ Motor Leakage Inductance Setting

d2-05 will be set automatically during Auto-Tuning.

□ Motor Rotor Resistance and Mutual Inductance Setting

6.6 Group E, Multi-Function Terminals

E1 Multi-Function Digital Inputs

■ E1- 00 to E1- 05 Terminal S1 to S6 Function Selection

Assigns functions to multi-function terminals S1 to S6. Set this parameter according to Table 6.18.

No.	Name	Setting Range	Default
E1-00	Terminal S1 Function Selection	0 to 73	0 : 2-Wire Sequence Control (Forward/Stop)
E1-01	Terminal S2 Function Selection	0 to 73	1: 2-Wire Sequence Control (Forward/Stop)
E1-02	Terminal S3 Function Selection	0 to 73	23 : External Fault
E1-03	Terminal S4 Function Selection	0 to 73	39: Fault Reset
E1-04	Terminal S5 Function Selection	0 to 73	9: Jog Frequency
E1-05	Terminal S6 Function Selection	0 to 73	19: Baseblock Command (Normal Open.)

Table 6.18

Setting	Functions	Setting	Functions
0	2-Wire Sequence Control (Forward/Stop)	41	Retain
1	2-Wire Sequence Control (Reverse/Stop)	42	Retain
2	3-Wire Sequence	43	Retain
3	Local/Remote Selection	44	Retain
4	Retain	45	Communication Mode
5	Multi-Step Speed Command 1	46	PID Disable
6	Multi-Step Speed Command 2	47	PID Integral Reset
7	Multi-Step Speed Command 3	48	PID Integral Hold
8	Multi-Step Speed Command 4	49	PID Soft-Start On/Off
9	Jog Frequency	50	PID Input Characteristics Switch
10	Up Command	51	Motor 1/2 Switch
11	Down Command	52	Timer Input
12	Up2 Command	53	Offset Frequency 1
13	Down2 Command	54	Offset Frequency 2
14	FJOG Command	55	Offset Frequency 3
15	RJOG Command	56	Retain
16	Acc./Dec. Time Selection 1	57	Retain
17	Retain	58	Retain
18	Acc./Dec. Ramp Hold	59	Retain
19	Baseblock Command (Normal Open)	60	Program Lockout
20	Retain	61	Analog Frequency Command Hold
21	Fast Stop (Normal Open)	62	Retain
22	Retain	63	Retain
23	External Fault 1	64	Retain
24	External Fault 2	65	DC Braking
25	External Fault 3	66	Retain
26	External Fault 4	67	Retain
27	External Fault 5	68	Retain
28	External Fault 6	69	Drive Enabled
29	External Fault 7	70	Retain
30	External Fault 8	71	Retain
31	External Fault 9	72	Retain
32	External Fault 10	73	Retain
33	External Fault 11		

34	External Fault	12		
35	External Fault	13		
36	External Fault	14		
37	External Fault	15		
38	External Fault	16		
39	Fault Reset			
40	oH2 (AC drive Overheat Alarm)			

0 : Forward/ Stop

1 : Reverse/ Stop

2 : 3-Wire Sequence Control

The multi-function input terminal S3 to S6 can be assigned to 3-Wire Sequence Control to be the input terminal for Forward/ Reverse Command. And terminals S1 and S2 will be automatically assigned to Run and Stop command separately.

When terminal S1 (Run command) closes for longer than 2ms, the drive runs the motor. When terminal S2 (Stop command) opens for even an instant, the drive stops the motor. When the input terminal assigned to 3-wire sequence control opens, the drive runs in forward direction, and when it is closed, the drive runs in reverse direction.

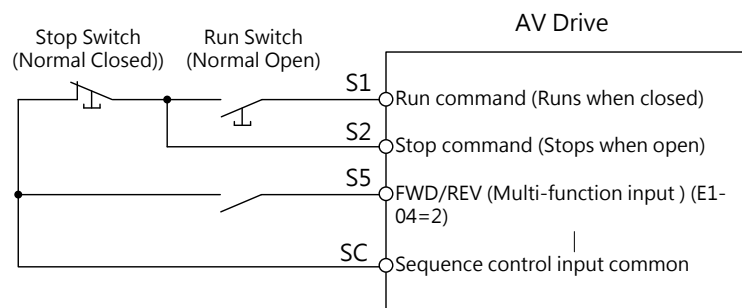

Table 6.44 3-Wire Sequence Wiring Diagram

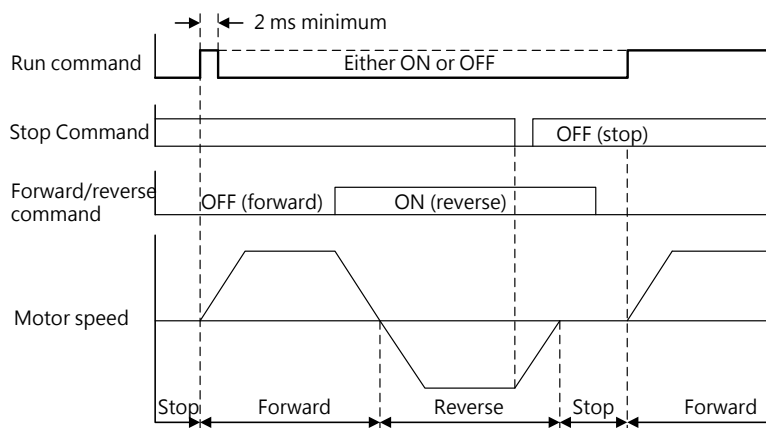

Table 6.45 3-Wire Sequence Operation

Note:

1. When entering a Run command, close the terminal for minimum 2 ms.
2. If the Run command is active at power up and b1-10 (Run Command at Power up)= 0 (Ignore), the protection will be triggered and LED indicator will flash. Set b1-10 (Run Command at Power up)=1 (Accept) to accept an active Run command at power up.

WARNING! Safety during Machinery Restart

- Make sure wiring for Run/ Stop and safety circuits are correct and check if the machinery is normal after applying power to the drive. Improper wiring could cause inquiry due to machinery sudden movement. When setting 3-wire sequence control, the drive could suddenly start running due to the control circuit momentarily close.
- If the Run command is active at power up with 3-wire sequence wiring and 2-wire sequence setting (default), the motor will run in reverse direction at power up. To avoid this, set b1-10 (Run Command at Power up)=0 (Ignore) to ignore an active Run command at power up.

3 : Local / Remote Selection

Switch the command source (Local/ Remote) by opening/ closing the terminal.

Terminal	Description
Open	Remote (If no terminal is assigned to E1-□□=4, b1-00 and b1-01 are enabled. If a multi-function input terminal is assigned to E1-□□=4, this terminal determines the source for frequency command and Run command.)
Closed	Local (Frequency command and Run command are entered from the keypad.)

Note:

1. When a multi-function input terminal is assigned to Local/ Remote, the LO/RE key on the keypad is disabled.
2. LED indicator is lit in Local mode.
3. Local/ Remote cannot be switched during run. Refer to b1-05 for the run command action after switch.

4 : Command Source 1/2 Selection

Switches the command source by opening/ closing the terminal as per the following table.

Terminal	Description
Open	b1-00 (Frequency Command Selection 1) , b1-01 (Run Command Selection 1)
Closed	b1-07 (Frequency Command Selection 2) , b1-08 (Run Command Selection 2)

Note: This cannot be switched during run.

5 to 8 : Multi-Step Speed Command 1 to 4

Switches multi-step speed frequency commands L1-00 to L1-15. Refer to L1-00 to L1-15 (Frequency Command 1 to 16) for details.

9 : Jog Frequency

The Job frequency set by L1-16 is enabled when the terminal is closed. And the acceleration and deceleration time will be the values set to C1-11 and C1-12.

10/ 11 : Up/Down Command

Allows the frequency command to be set to two external terminals. Always set E1-□□= 10 (Up Command) and E1-□□= 11 (Down Command) in pair. To set the frequency by Up/ Down command, set b1-00 or b1-07 (Frequency Command Selection) to 2 (Terminal Up/Down) according to the following table.

Terminal		Drive Operation
Up Command (10)	Down Command (11)	
Open	Open	Hold the current frequency command
Closed	Open	Increase frequency command
Open	Closed	Decrease frequency command
Closed	Closed	Hold the current frequency command

Note: When only either of Up or Down command is assigned, an oPE03 (Multi-Function Input Selection Error) alarm will be triggered.

Using Up/ Down Function with Frequency Command Hold (L4-00)

- When the Run command is removed and L4-00 =0 (Frequency Command Hold Disabled), the Up/ Down command will be reset to 0.
- When L4-00=1 (Frequency Command Hold Enabled), the drive will save the frequency command set by Up/ Down command. When the drive stops, the frequency command will be saved. To reset the saved command to 0, remove the Run command and close the Up or Down input. Refer to L4-00 for details.

Using Up/ Down Function with Frequency Command Limits (L2)

- The frequency command upper limit is set in L2-00.
- The frequency command lower limit can be set by analog input or L2-01. If the analog input is set to 2, whichever smaller from the analog input or the L2-01 setting is the lower limit.

Up/ Down command operation is illustrated in the following figure. In this example, the frequency command lower limit is determined by L2-01.

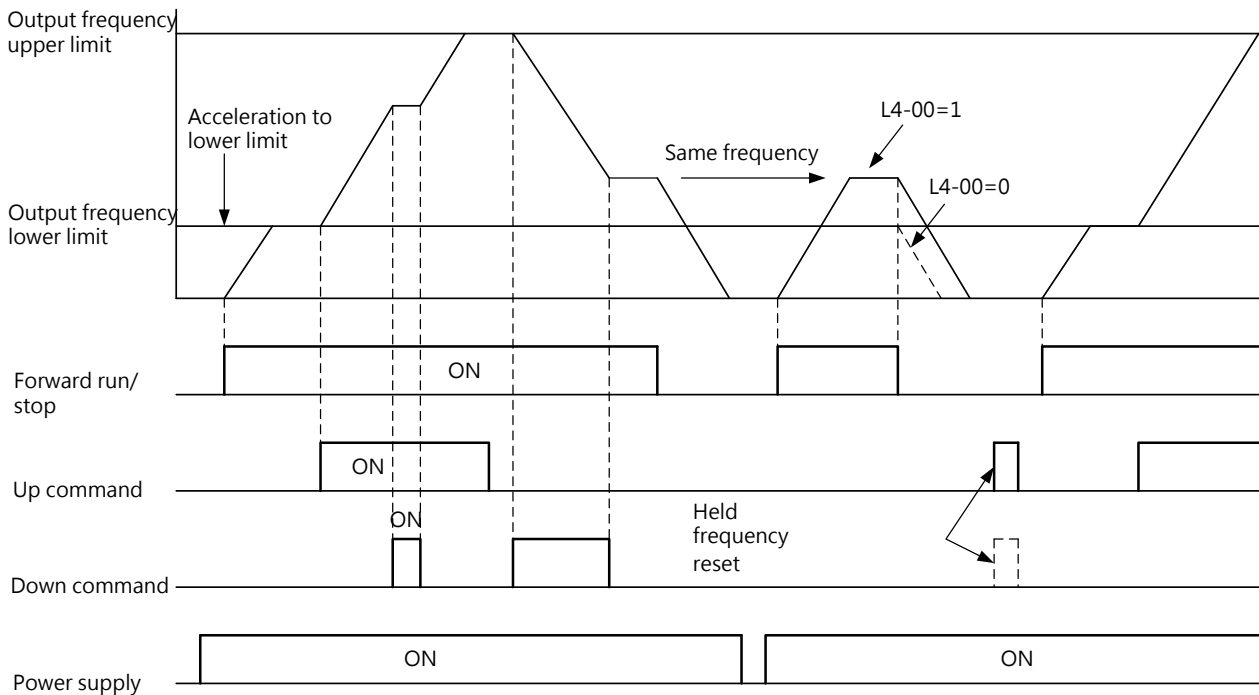

Figure 6.46 Up/ Down Command Operation

12/ 13: Up2/ Down 2 Command

Increases or decreases the frequency command bias. Refer to parameter L2 for details.

14/ 15: FJOG/RJOG Command

FJOG/RJOG commands are Jog frequency which do not require a Run command. And the acceleration and deceleration time will be the values set to C1-11 and C1-12. If the input terminal assigned to FJOG command is closed, the drive runs in forward direction at the frequency set to L1-16. The RJOG command also causes the same action in reverse direction. The FJOG and RJOG command can be set independently.

Note:

- The FJOG/ RJOG command overrides all other frequency commands. However, RJOG command is disabled when b1-03= 1 (Reverse Rotation Disabled).
- Entering both the FJOG and RJOG commands simultaneously for 500 ms or longer will trigger an alarm and the drive will ramp to stop.

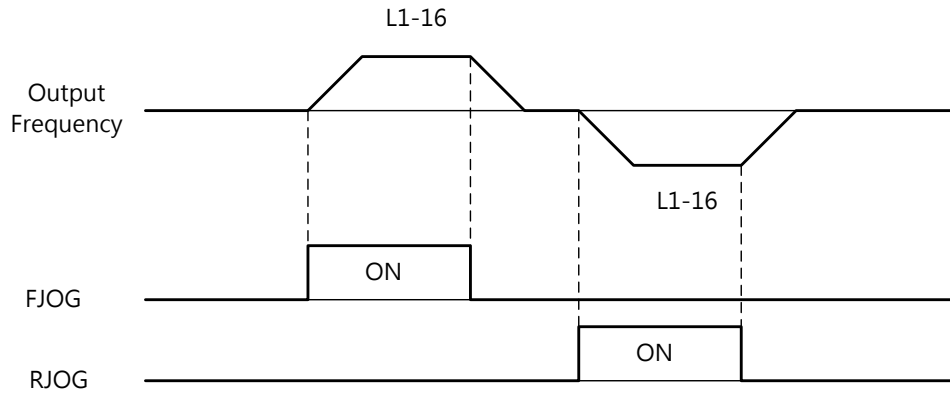

Figure 6.47 FJOG/ RJOG Command Operation

16 : Acc./Dec. Time Selection 1

Switches between C1-00, C1-01 (Acc./Dec. Time 1) and C1-02, C1-03 (Acc./Dec. Time 2) by opening or closing the terminal. Refer to C1-00 to C1-07 (Acc./Dec. Time 1 to 4) for details.

17 : Acc./Dec. Time Selection 2

Selects acceleration and deceleration times 1 to 4 in combination with E1-□□= 16 (Acc./Dec. Time Selection 1). Refer to C1-00 to C1-07 (Acc./Dec. 1 to 4) for details.

18 : Acc./Dec. Ramp Hold

When the terminal is closed, the drive holds the output frequency. When the terminal is reopened, the drive resumes the acceleration or deceleration. Refer to L4-00 (Frequency Command Hold) for details.

19: Baseblock Command (Normal Open)

20: Baseblock Command (Normal Closed)

A baseblock command shuts off the drive output immediately causing the motor to coast and the *bb* (baseblock) alarm to flash. When baseblock ends while a Run command is active, Speed Search will be performed to restart the motor.

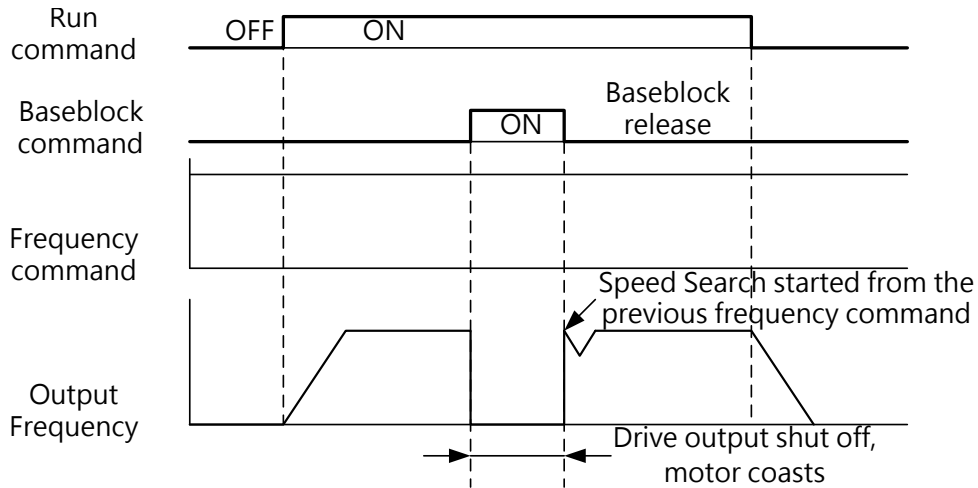

Figure 6.48 Baseblock Operation

Drive Operation	Input	
	Setting 19 (Normal Open)	Setting 20 (Normal Closed)
Normal operation	Open	Closed
Baseblock (drive output shut off)	Closed	Open

WARNING! In a lifting application, a baseblock command will shut off the drive output and cause the motor to coast. Therefore always make sure the brake is closed. Failure to comply could result in injury caused by a slipping load.

21/ 22: Fast Stop (Normal Open/ Normal Closed)

If a fast stop command is entered during run, the drives use the deceleration time set in C1-08 to stop the motor. Refer to C1-08 (Fast Stop Time). Once the fast stop command is entered, The drive can be restarted until a fully stop, removing the Fast Stop input and the Run command.

- To trigger Fast Stop with a normal open terminal, set E1-□□= 21.
- To trigger Fast Stop with a normal closed terminal, set E1-□□= 22.

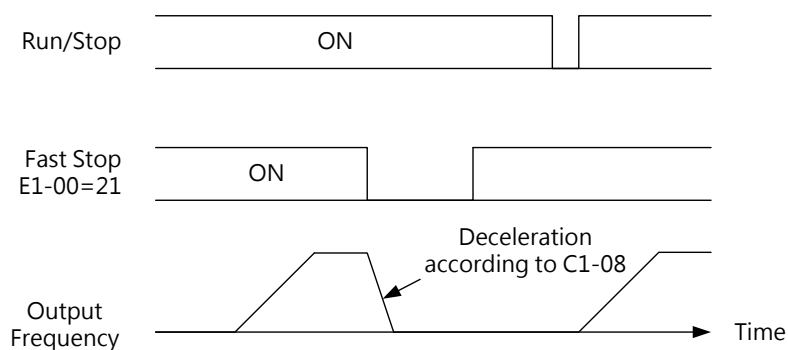

Figure 6.49 Fast Stop Operation

WARNING! Rapid deceleration could trigger an overvoltage fault. When the fault is triggered, the drive output

will be shut off the motor will coast resulting uncontrolled motor state. To avoid this, set an appropriate deceleration time to C1-08.

23 to 38 : External Fault

Stops the drive when problems occur with external devices.

To use the external fault function, set E1-00 to E1-05=23 to 38. While an external fault is triggered, EF□ will be displayed on the keypad where □ is the number of the terminal assigned to the external fault signal. For example, if an external fault signal is input to terminal S3, then EF3 will be displayed.

Selects the value to set to E1-□□ from a combination of the following three conditions:

- Input signal from peripheral devices
- Detection method of external fault
- Stopping method (for external fault detection)

The following table shows the combination of the conditions.

Setting	Input Signal <1>		Detection Method <2>		Stopping method			
	Normal Open	Normal Close	Always Detected	Detected during Run only	Ramp to Stop (fault)	Coast to Stop (fault)	Fast Stop (fault)	Alarm Only (continue operation)
23	<input type="radio"/>		<input type="radio"/>		<input type="radio"/>			
24		<input type="radio"/>	<input type="radio"/>		<input type="radio"/>			
25	<input type="radio"/>			<input type="radio"/>	<input type="radio"/>			
26		<input type="radio"/>		<input type="radio"/>	<input type="radio"/>			
27	<input type="radio"/>		<input type="radio"/>			<input type="radio"/>		
28		<input type="radio"/>	<input type="radio"/>			<input type="radio"/>		
29	<input type="radio"/>			<input type="radio"/>		<input type="radio"/>		
30		<input type="radio"/>		<input type="radio"/>		<input type="radio"/>		
31	<input type="radio"/>		<input type="radio"/>				<input type="radio"/>	
32		<input type="radio"/>	<input type="radio"/>				<input type="radio"/>	
33	<input type="radio"/>			<input type="radio"/>			<input type="radio"/>	
34		<input type="radio"/>		<input type="radio"/>			<input type="radio"/>	
35	<input type="radio"/>		<input type="radio"/>					<input type="radio"/>
36		<input type="radio"/>	<input type="radio"/>					<input type="radio"/>
37	<input type="radio"/>			<input type="radio"/>				<input type="radio"/>
38		<input type="radio"/>		<input type="radio"/>				<input type="radio"/>

<1> Determine the terminal status to detect the fault. (Normal Open: detection when terminal closed, normal closed: detection when terminal open)

<2> Determine the detection should be enabled only during run or always detected.

39: Fault Reset

When a fault is detected, close the assigned terminal output, shut off the drive output and stop the motor. Most of the faults cause the motor to coast, but stopping method can be set for some faults (e.g. P1-03 Motor Overheat Fault Operation Selection). To restart the drive, either remove the Run command, press the RESET key () on the keypad, or set 39 (Fault Reset) to any terminal input in E1-00 to E1-07 and close the terminal input.

Note: A fault reset signal will be ignored during run. Remove the Run command to perform fault reset.

40 : oH2 (AC drive Overheat Alarm)

When the input terminal is closed, oH2 alarm is triggered (the drive continue operation).

41 : Retain

45 : Communication Mode

Set this when using communications. The assigned terminal input can receive signals from Modbus or optional communication card.

46 : PID Disable

Even if PID control is enabled by b5-00 (PID Control Setting), closing the assigned input terminal will disable it. PID control remains active when the terminal is open.

47 : PID Integral Reset

Resets the PID control integral value to 0 when closing the input terminal.

48 : PID Integral Hold

Holds the PID integral value when the input terminal is closed, and restarts PID integral when the terminal is open.

49 : PID Soft-Start On/Off

Disables b5-16 (PID Command Acc./Dec. Time) when the input terminal is closed and enables it when the terminal is open.

50 : PID Input Characteristics Switch

Switches the PID input characteristics.

51 /52: Retain

53/54/55 : Offset Frequency 1/ 2/ 3

Adds offset frequencies L6-00 to L6-02 to the frequency command when the terminal is closed. Refer to L6-00 to L6-02 (Offset Frequency 1/ 2/ 3).

56 to 59: Retain

60 : Program Lockout

When the input terminal is closed parameter settings can be changed. When the input terminal is open, all the parameter settings other than U1-01 (Frequency Command Monitor) cannot be changed. However parameter settings can always be viewed.

61 : Analog Frequency Command Hold

Sample the frequency command being input to terminal A1, A2 at which the drive will run. When the input terminal is closed for 100ms, the drive same the frequency command and hold the level as illustrated in the following figure. When the power is cut off, the held frequency command will be cleared and the frequency command will be reset to 0.

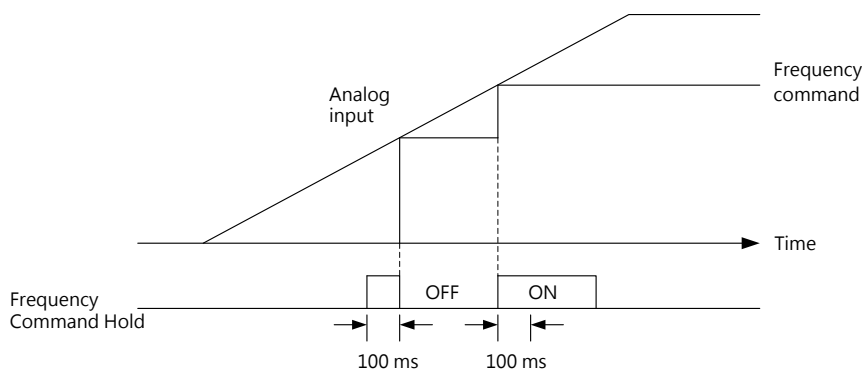

Figure 6.51 Analog Frequency Command Hold Operation

When this function is used with any of the following function at the same time, an oPE12 error will be triggered.

- Setting 18 (Acc./Dec. Ramp Hold)
- Setting 10 and 11 (Up/Down Command)
- Setting 53 to 55 (Offset Frequency 1/ 2/ 3)
- Setting 12 and 13 (Up 2/ Down 2 Command)

62 to 64: Retain

65 : DC Braking

Stops the motor during deceleration. When a Run command or Jog command is entered, the DC braking will be removed as illustrated in the following figure. Refer to b2 (DC Braking) for details.

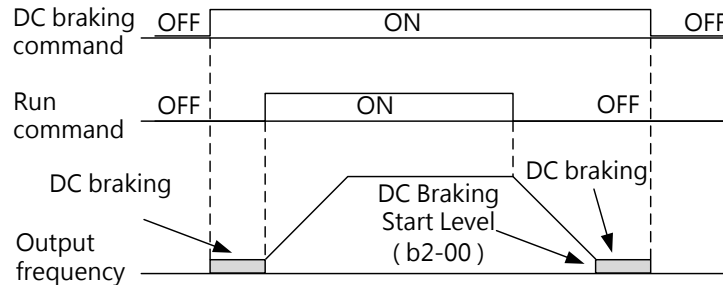

Figure 6.52 DC Braking Operation

66 to 68: Retain

69 : Drive Enabled

The drive does not accept any Run command until the input terminal closes. When the input terminal is open, the keypad will display "DNE" .

If a Run command is entered before the assigned terminal closes, then drive will not run until the Run command is cycled. If the terminal is open during run, the drive will stop according to b1-02 (Stopping Method Selection). Refer to b1-02 for details.

70 to 73: Retain

E2 Multi-Function Digital Output

■ E2- 00 Relay 1

The drive has four multi-function output terminals. Assign the functions to E2-00 to E2-03 according to Table 6.20.

No.	Parameter Name	Setting Range	Default
E2-00	Relay 1 Function Selection	0 to 149	0: During run

Table 6.20 Multi-Function Output Terminal Settings

Setting	Function	Setting	Function
0	During Run	29	Retain
1	Zero Speed Holding	30	Retain
2	Frequency (Speed) Agree	31	Retain
3	User-Defined Frequency (Speed) Agree	32	Retain
4	Drive Ready	33	Retain
5	Uv (Undervoltage) Detection	34	Retain
6	During Baseblock	35	During Frequency Output
7	Retain	36	Drive Enabled
8	Frequency Command Source	37	Retain
9	Frequency Command Loss	38	Local/Remote Mode
10	Run Command Source	39	During Speed Search
11	Fault	40	PID Feedback Low
12	Communication Mode	41	PID Feedback High
13	Alarm	42	Retain
14	Fault Restart	43	Retain
15	Retain	44	During Fast Stop
16	Frequency (FOUT) Detection 1	45	Retain
17	Frequency (FOUT) Detection 2	46	Retain
18	Overvoltage/Undervoltage Detection 1	47	Retain
19	Retain	48	Retain
20	Retain	49	Retain
21	Retain	100~149	0~49 Inverse Output
22	During Reverse		
23	Retain		
24	During Regeneration		
25	Restart Enabled		
26	Motor Overload Pre-Alarm (oL1) (Including oH3)		
27	Drive Overheat Pre-Alarm (oH)		
28	Retain		

0 : During Run

When the drive is outputting voltage, the output terminal closes.

Terminal	Description
Open	The drive is stopped.

Closed	A Run command is input or the drive is during DC braking or deceleration
--------	--

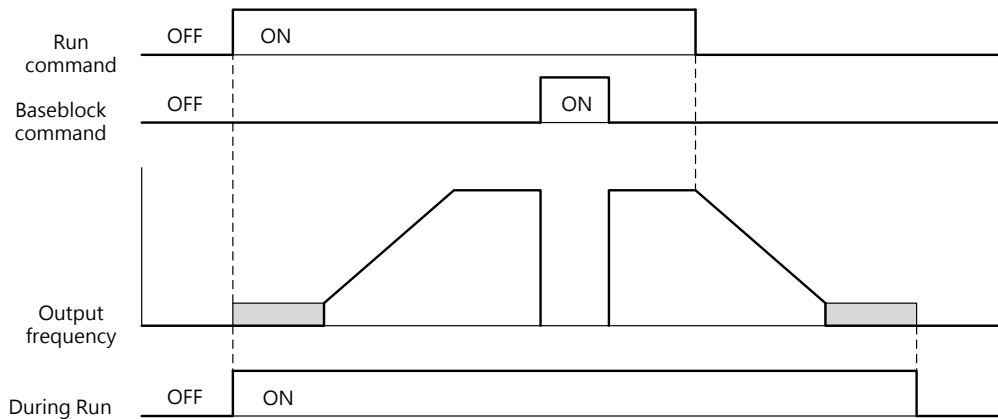

Figure 6.53 During Run Operation

1 : Zero Speed Holding

When the output frequency falls below the d1-08 (Minimum Output Frequency) or b2-00 (Zero Speed Holding Start Level) setting, the output terminal closes.

Terminal	Description
Open	Output frequency is higher than the d1-08 or b2-00 setting
Closed	Output frequency is lower than the d1-08 or b2-00 setting

Note: In IM/ PM Closed-Loop Vector Control, the terminal closes when the output frequency falls below the b2-00 setting. In all other control method, the terminal closes when the output frequency falls below the d1-08 setting.

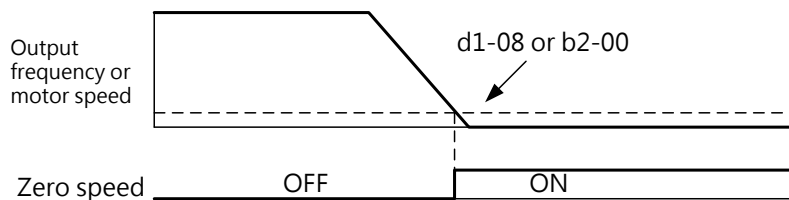

Figure 6.54 Zero Speed Holding Operation

2 : Frequency (Speed) Agree

When the output frequency is within the value set to $\pm P4-01$ (Frequency Detection Width), the output terminal closes regardless the rotation direction.

Terminal	Description
Open	The output frequency does not match the frequency demand during run
Closed	Output frequency is within the value set to $\pm P4-01$

Note:

1. The detection works in both forward and reverse directions.
2. In Closed-Loop Vector Control, the terminal closes when the motor speed is within the value set to P4-01.

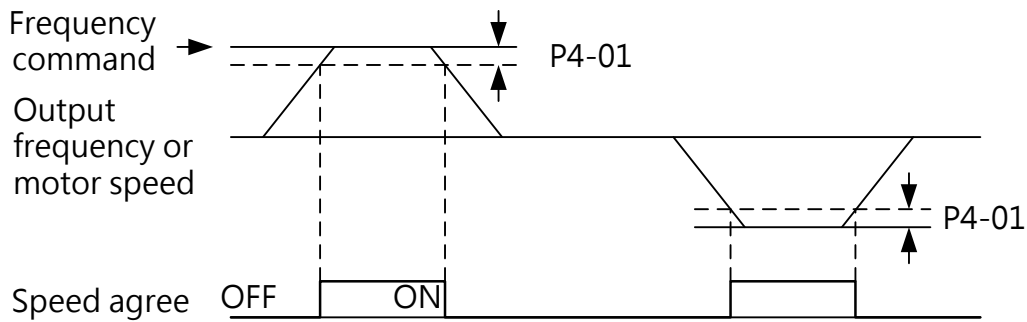

Figure 6.55 Speed Agree Operation

3 : User-Defined Frequency (Speed) Agree

When the output frequency and frequency command are both within the P4-00 (Frequency Detection Level) level plus or minus the P4-01 (Frequency Detection Width) value, the output terminal closes.

Terminal	Description
Open	Output frequency or frequency command is outside of the range of $(P4-00 \pm P4-01)$
Closed	Output frequency and frequency command are both within the range of $(P4-00 \pm P4-01)$

Note:

1. The detection and the P4-00 level work in both forward and reverse directions.

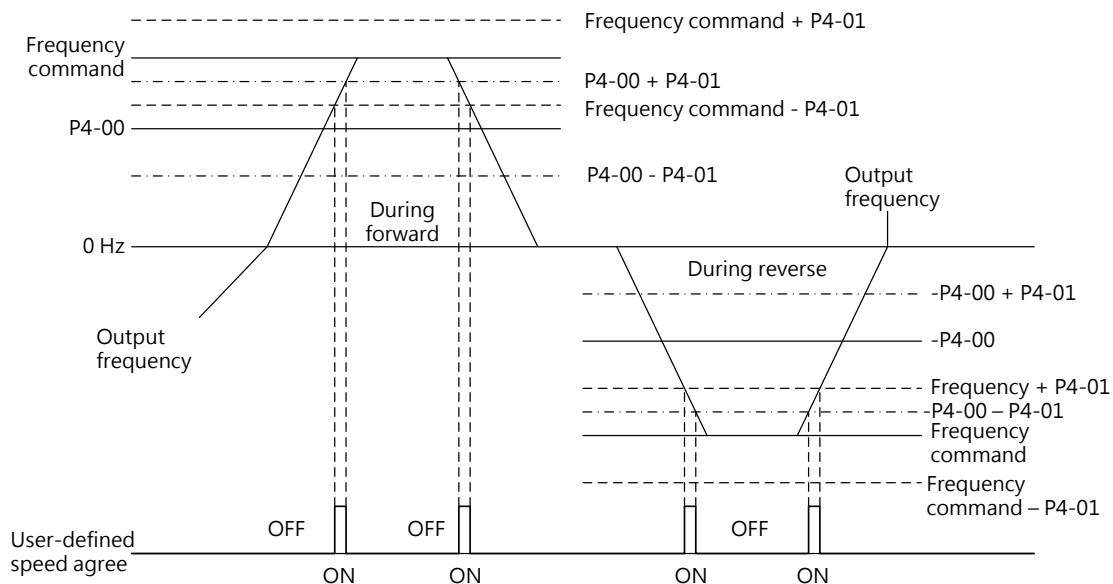

Figure 6.56 User-Defined Frequency (Speed) Agree Operation

4 : Drive Ready

When the drive is ready to run or during run, the output terminal closes. According to the conditions listed below, when a fault occurs or the drive cannot run even if a Run command is

entered, the output terminal closes.

- When the power is cut off
- During a fault
- When the internal power supply of the drive malfunctions
- When an improper parameter setting makes the drive unable to run
- An overvoltage or undervoltage fault is triggered during stop
- When setting a parameter in the programming mode

5 : Uv (Undervoltage) Detection

When the main circuit DC voltage falls below the Uv detection level, the output terminal closes. The Uv detection level is set in P2-03.

Terminal	Description
Open	The main circuit voltage is higher than the P2-03 level
Closed	The main circuit voltage is lower than the P2-03 level

6 : During Baseblock

During baseblock, the output terminal closes and the output transistors do not switch.

Terminal	Description
Open	The drive is not performing baseblock
Closed	The drive is performing baseblock

7: Retain

8 : Frequency Command Source

Displays the currently selected frequency command source.

Terminal	Description
Open	Frequency command is provided from external command 1 (b1-00) or 2 (b1-07)
Closed	Frequency command is provided from the drive keypad

9 : Frequency Command Loss

When a frequency command loss is detected, the assigned output terminal closes. Refer to P4-02 (Frequency Command Loss Detection Selection) for details.

10: Run Command Source

Displays the currently selected Run command source.

Terminal	Description
Open	Run command is provided from external command 1 (b1-01) or 2 (b1-08)
Closed	Run command is provided from the drive keypad.

11 : Fault

When a fault is triggered, the assigned output terminal closes.

12 : Communication Mode

If the terminal is assigned to 12, it can be the output terminal for the upper controller using Modbus communication. If the signal is not set by the controller, the signal will not perform any action.

13 : Retain

14 : Fault Restart

When attempting to reset a fault from the control circuit terminals, via serial communications, the assigned output terminal closes.

15 : Retain

16 : Frequency (FOUT) Detection 1

When the output frequency exceeds the P4-00 (Frequency Detection Level) level plus the P4-01 (Frequency Detection Width) level, the assigned output terminal closes until the output frequency reaches the P4-00 level.

Terminal	Description
Open	The output frequency exceeds the P4-00 level plus the P4-01 level
Closed	The output frequency does not exceed the P4-00 level plus the P4-01 level

Note:

1. The detection and the P4-00 level work in both forward and reverse directions.

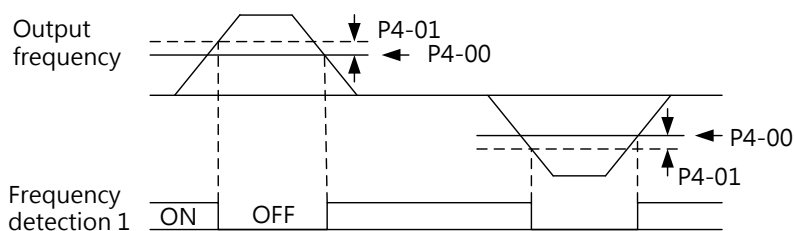

Figure 6.57 Frequency (FOUT) Detection 1 Operation

17 : Frequency (FOUT) Detection 2

When the output frequency exceeds the P4-00 (Frequency Detection Level) level, the assigned output terminal closes until the output frequency reaches the P4-00 level minus the P4-01 value.

Terminal	Description
Open	The output frequency does not exceed the P4-00 level, or below the P4-00 level minus the P4-01 value.
Closed	The output frequency exceeds the P4-00 level

Note:

1. The detection and the P4-00 level work in both forward and reverse directions.

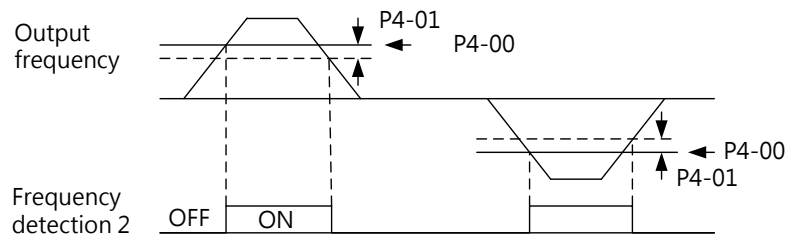

Figure 6.58 Frequency (FOUT) Detection 2 Operation

18/20: Overvoltage/ Undervoltage Detection 1/2

Outputs the overvoltage or undervoltage situations to the external devices. Set the torque detection and the output setting listed below. Refer to P6 (Overtorque/ Undertorque Detection) for details.

Setting	Terminal	Description
18	Open	Overvoltage/ Undervoltage Detection 1 (Normal Open) The output current or torque exceeds the P6-01 (Overtorque/ Undertorque Detection Level 1) level for the P6-02 (Overtorque/ Undertorque Detection Time 1) time

22 : During Reverse

When the motor run in the reverse direction, the assigned output terminal closes.

Terminal	Description
Open	The motor runs in the forward direction
Closed	The motor runs in the reverse direction

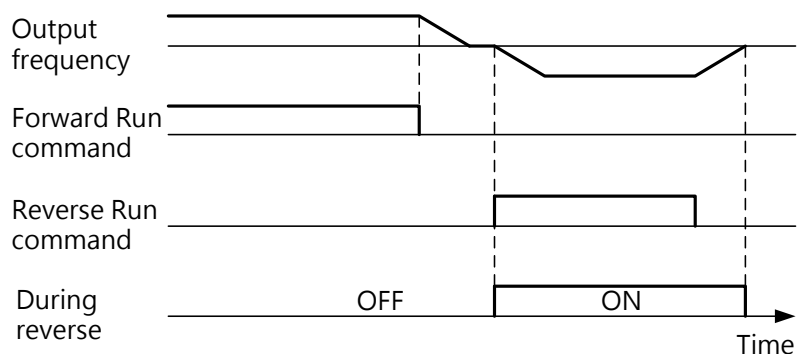

Figure 6.59 During Reverse Operation

23: Retain

24: During Regeneration

When the motor outputs during regeneration, the assigned output terminal closes.

25 : During Restart

When the drive attempts to clear a fault during restart, the assigned output terminal closes. If the fault is cleared after restart, the output terminal opens. If the number of restart attempt reaches the number set to P5-00 (Number of Auto Restart Attempts) without clearing a fault successfully, the output terminal opens after the fault is triggered.

26 : Motor Overload Pre-Alarm (oL1)

When the motor overload level exceeds 90% of the detection level, the assigned output terminal closes. Refer to P1-00 (Motor Protection Function Selection) for details.

27 : Drive Overheat Pre-Alarm (oH)

When the drive heatsink temperature exceeds the oH (overheat) detection level, the assigned output terminal closes.

28 : Retain

29 to 34: Retain

35: During Frequency Output

When the drive is outputting frequency, the assigned output terminal closes.

Terminal	Description
Open	The drive is during stop, baseblock or DC braking.
Closed	The drive is outputting frequency

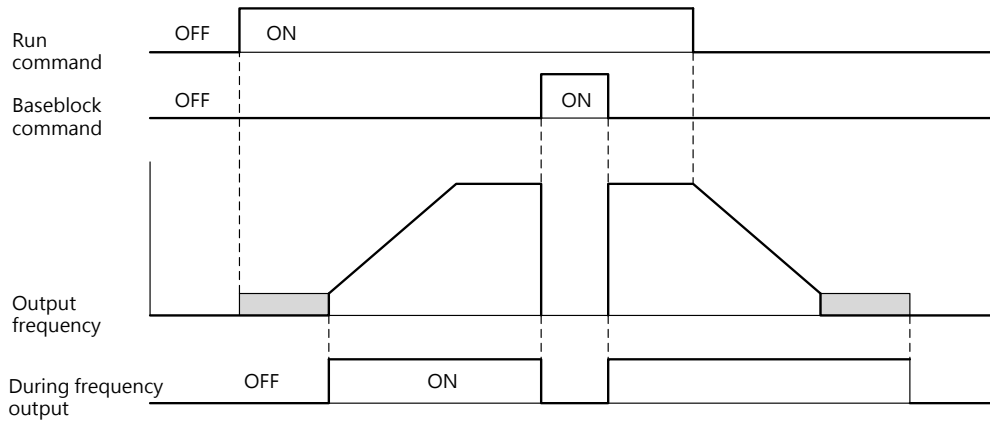

Figure 6.60 During Frequency Output Operation

36: Drive Enabled

Shows the status of multi-function terminal input E1-□□= 69 (Drive Enabled). When the input terminal E1-□□= 69 is closed, the output terminal closes as well.

37: Retain

38 : Local/Remote Mode

The output terminal closes in Local mode and opens in Remote mode.

Terminal	Description
Open	Remote: The frequency and Run command can be provided by the external device selected by b1-00/b1-01 or b1-07/b1-08.
Closed	Local: The frequency and Run command can be provided by the drive keypad.

39 : During Speed Search

The assigned output terminal closes during Speed Search. Refer to b3 (Speed Search) for details.

40 :PID Feedback Low

When a PID Feedback Low is detected, the assigned output terminal closes. When the PID feedback value falls below the b5-12 level for longer than the time set to b5-13, the fault will be detected.

41 :PID Feedback High

When a PID Feedback High is detected, the assigned output terminal closes. When the PID feedback value exceeds the b5-22 level for longer than the time set to b5-23, the fault will be detected.

42 to 43 : Retain

44 : During Fast Stop

The assigned output terminal closes during a fast stop. Refer to setting 21 and 22 (Fast Stop) of multi-function Digital Inputs.

45 to 47 : Retain

48 : During Wobble operation

The assigned output terminal closes during wobble function operation.

49 : Retain

E3 Multi-Function Analog Input

The drive has two multi-function analog inputs (A1). Set the terminal A1 according to Table 6.21.

E3- 00 Terminal A1 Signal Level Selection

Sets the signal level for terminal A1.

No.	Name	Setting Range	Default
E3-00	Terminal A1 Signal Level Selection	0, 3	2

0 : 0 to 20 mA

1 : 4 to 20 mA

2 : 0 to 10 V

Inputs a 0 to 10 V signal. A negative signal by the gain and voltage bias is limited to 0%.

3 : 0 to 5 V

Inputs a 0 to 5 V signal. A negative signal by the gain and voltage bias is limited to 0%.

■ E3- 01 Terminal A1 Function Selection

Select the function to terminal A1.

No.	Name	Setting Range	Default
E3-01	Terminal A1 Function Selection	0 to 19	0

■ E3-02/ E3-03 Terminal A1 Input Gain/ Voltage Bias

E3-02 sets the terminal A1 input gain as a percentage when inputting 10V. E3-03 sets the terminal A1 input voltage bias as a percentage when inputting 0V. Terminal A1 input characteristics are determined by E3-02 and E3-03.

No.	Name	Setting Range	Default
E3-02	Terminal A1 Input Gain	-999 to 999.9%	100.0%
E3-03	Terminal A1 Voltage Bias	-999 to 999.9%	0.0%

Examples

- Gain = 200%, voltage bias = 0%, terminal A1 is used as frequency command input (E3-01 = 0)

When inputting a 10 V signal, the frequency command will be 200%. When inputting a 5V signal, the frequency command is 100%.

As the drive output is limited by d1-02 (Maximum Output Frequency), the frequency command will be 100% when the signal is 5 V and above.

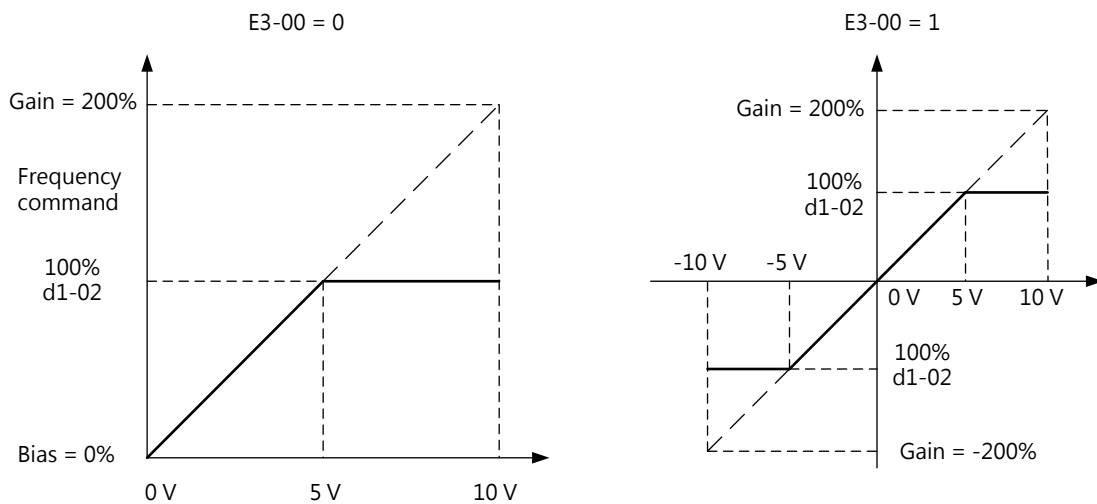

Figure 6.62 Frequency Command Adjusted by Input Gain and Bias

- Bias = -25%, terminal A1 is used as frequency command input

When inputting a 0 V signal, the frequency command will be -25%.

When E3-00=0 and inputting a signal between 0 to 2 V, the frequency command will be 0%.

When E3-00=0 and inputting a signal between 2 to 10 V, the frequency command will be between 0 to 100%.

When E3-00=1 and inputting 0 to 2 V, the motor will run in the reverse direction.

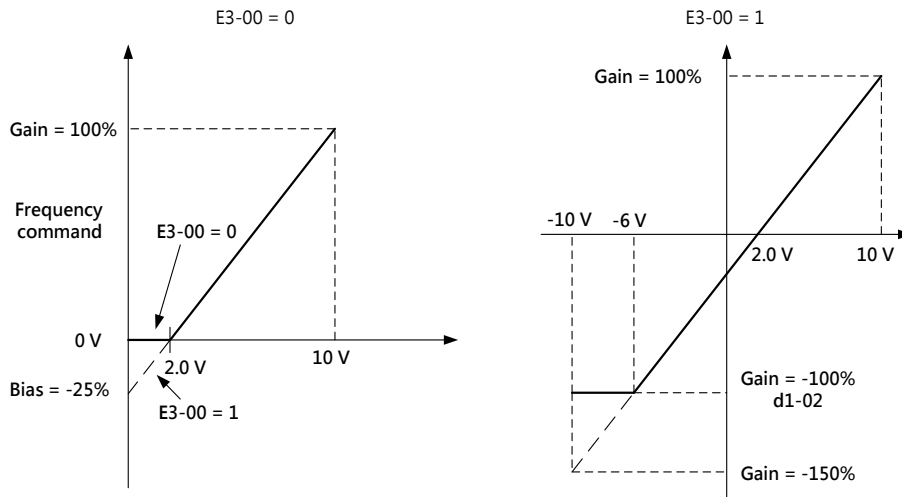

Figure 6.63 Frequency Command Adjusted by Input Gain and Negative Bias

■ E3-04 Retain

■ E3-05 Terminal A1 Input Filter Time

Sets the terminal A1 primary delay filter time, which can stabilize the drive operation by eliminating the interference. Long filter time stabilizes the drive but causes slow response to the analog input signal changes.

No.	Name	Setting Range	Default
E3-05	Terminal A1 Input Filter Time	0.01 to 2.00 s	0.05 s

■ Multi-Function Analog Input Terminal Settings

Assign the function listed in E3-01 and E3-07 to terminal A1 and A2 according to Table 6.21.

Note: The scaling of the functions listed below can be adjusted by the gain and bias. When assigning the function to the terminal, set an appropriate gain and bias.

Table 6.21 Multi-Function Analog Input Terminal Settings

Setting	Function	Setting	Function
0	Main Frequency Command	14	Retain
1	Retain	15	Retain
2	Output Frequency Lower Limit	16	Retain
3	Auxiliary Frequency Command	17	Retain
4	Output Voltage Bias	18	Communication Mode 1
5	Acc./Dec. Time Gain (Decrease Only)	19	Communication Mode 2
6	DC Braking (DB) Current		
7	Stall Prevention Level During Run		

8	PID Feedback		
9	PID Target		
10	Retain		
11	Overtorque/ Undertorque Detection		
12	Retain		
13	Retain		

0 : Main Frequency Command

Enters the frequency command via an analog input terminal when b1-00 or b1-07=1

1 : Retain

2 : Output Frequency Lower Limit

The output frequency lower limit can be adjusted by the analog input value.

3 : Auxiliary Frequency Command

Sets the auxiliary frequency command 1 when multi-step speed operation is selected.

4 : Output Voltage Bias

Voltage bias increases the output voltage of the V/F characteristics as a percentage of 200V or 400V depending on the power supply. This function is only available in the V/F Control method.

5 : Acc./Dec. Time Gain (Decrease Only)

Adjusts the gain for acc./ dec. time assigned to C1-00 to C1-07.

When the acceleration time is assigned to C1-00, the drive acceleration time is calculated below.

$$\text{Acc. Time} = \text{C1-00 Acc. time} \times \text{Acc./dec. time gain}$$

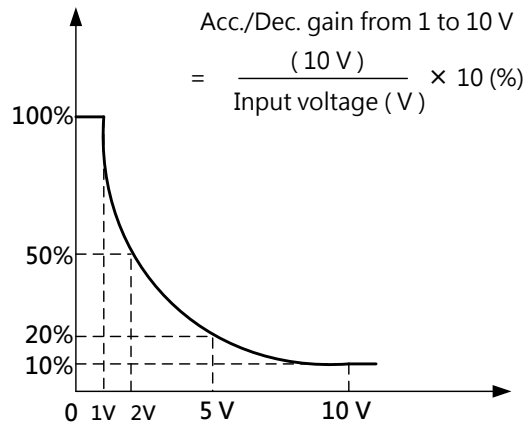

Figure 6.64 Acc./Dec. Time Gain Using Analog Input

6 : DC Braking (DB) Current

Adjusts the DC braking current by the analog input value.

When 10 V voltage or 20 mA current is input, the braking current will be 100% of the drive rated output current. The actual DC braking current is determined by the analog input value or the b2-01 value whichever is smaller.

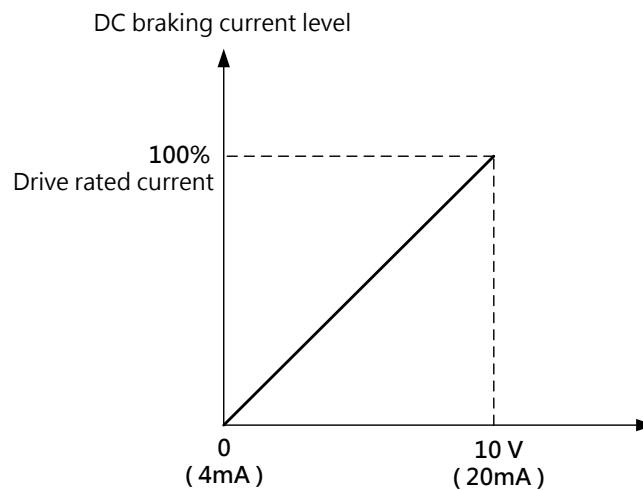

Figure 6.65 DC Braking Current Using Analog Input

7 : Stall Prevention Level During Run

Adjusts the stall prevention level by the analog input signal. The stall prevention level is determined by the analog input value or the P3-06 value whichever is smaller.

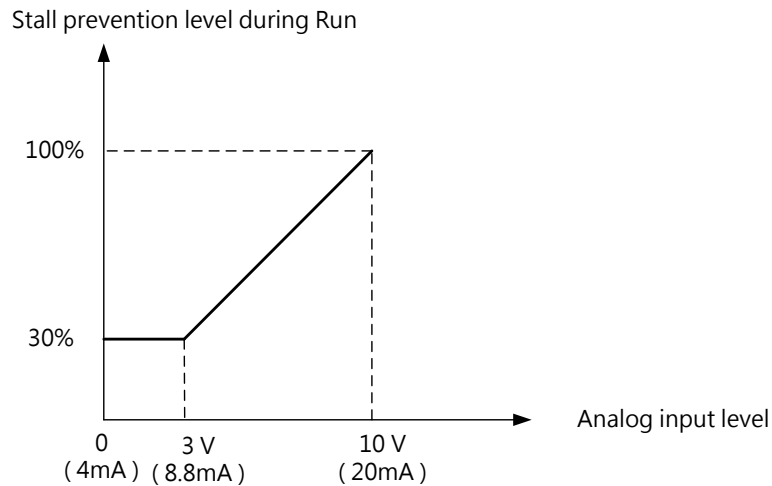

Figure 6.66 Stall Prevention Level Using Analog Input

8 : PID Feedback

Sets the PID feedback by the analog input value. To use this function, enable the PID control in b5-00.

9 : PID Target

Sets the PID target value by the analog input value. The frequency command entered by the command source selected in b1-00 (Frequency Command Selection 1) is disabled. To use this function, enable the PID control in b5-00.

10: Differential PID Feedback

Sets the differential PID feedback by the analog input value. The difference of the PID feedback input value and the differential feedback input value is used to calculate the PID input.

11 : Overtorque/ Undertorque Detection

Sets the detection level for overtorque and undertorque by the analog input value. Use the combination of this function and P6-00 (Overtorque/ Undertorque Detection Selection 1). This is the secondary source for P6-01 (Overtorque/ Undertorque Detection Level 1). When the input is 100% (10 V, 20 mA), the motor rated torque will be 100%. Refer to P6 (Overtorque/ Undertorque Detection) for details.

12 to 17 : Retain

18/19 : Communication Mode

If the terminal is assigned to 18 or 19, the input signal can be used as an analog input from the upper controller via Modbus.

E4 Multi-Function Analog Output

These parameters assign functions to terminal FM and AM to monitor the status of the drive.

■ E4-01 Terminal FM Monitor Selection

Selects the monitor for terminal FM and AM.

No.	Name	Setting Range	Default
E4-01	Terminal FM Monitor Selection	0 to 11	1

Setting	Function
0	Frequency Command
1	Output Frequency
2	Output Current
3	Motor Speed
4	Output Voltage
5	DC Voltage
6	Output Power
7	Retain
8	AI1 Input
9	Retain
10	Soft Starter Output Frequency
11	Retain

■ E4- 02/ E4- 03 Terminal FM Monitor Gain / Voltage Bias

E4-02 Sets the gain for terminal FM as a percentage.

E4-03 Sets the voltage bias for terminal FM as a percentage.

10 V equals 100% when setting E4-02, E4-03.

Figure 6.69 illustrates the gain and bias operation.

No.	Name	Setting Range	Default
E4-02	Terminal FM Monitor Gain	-999 to 999.9%	100.0%
E4-03	Terminal FM Voltage Bias	-999 to 999.9%	0.0%

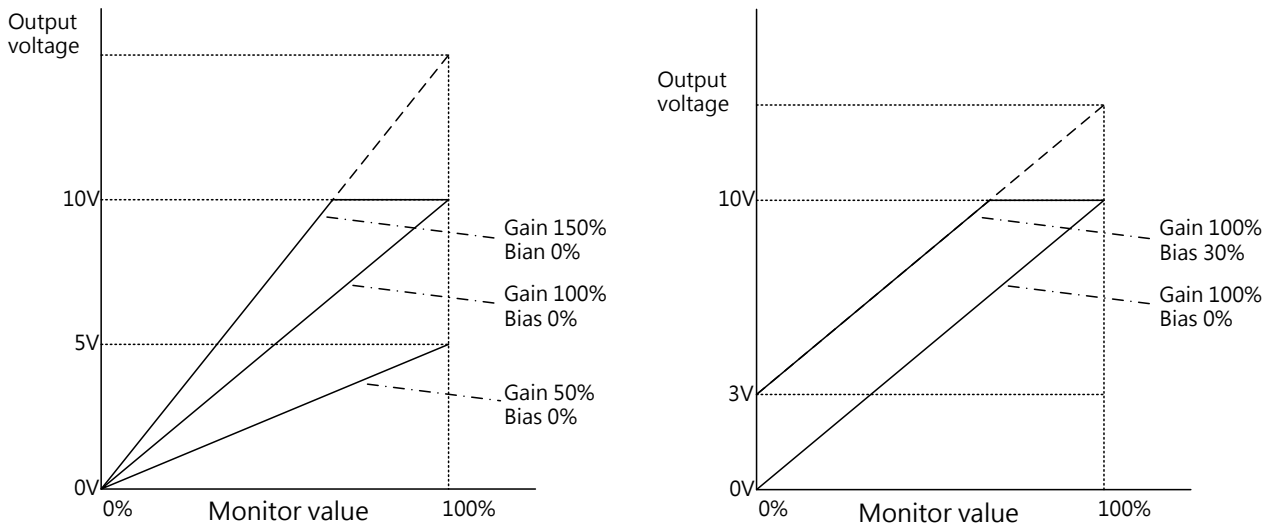

Figure 6.69 Analog Output Gain and Bias Operation

Check the setting value of E4-02, -03 when the monitor value is 100%.

Example 1: When E4-02 = 80% , the voltage output to terminal FM equals to 100% resulting 8 V.

Example 2: When E4-03 = 5% , the voltage output to terminal FM equals to 0% resulting 0.5 V.

E6 Communication Settings

■ E6-00 to E6-05 Retain

■ E6-06 Drive Station Address

No.	Name	Setting Range	Default
E6-06	Drive Station Address	1 to 31	1

■ E6-07 RS-485 Communication Speed Selection

No.	Name	Setting Range	Default
E6-07	RS-485 Communication Speed Selection	0 to 5	3

0: 1200 bps (bit/sec)

1: 2400 bps

2: 4800 bps

3: 9600 bps

4: 19200 bps

5: 38400 bps

■ **E6-08 RS-485 Communication Parity Selection**

No.	Name	Setting Range	Default
E6-08	RS-485 Communication Parity Selection	0 to 3	1

0: 8, N, 2 (MODBUS RTU)

1: 8, N, 1 (MODBUS RTU) (available for Remote Keypad)

2: 8, E, 1 (MODBUS RTU)

3: 8, O, 1 (MODBUS RTU)

■ **E6-09 Communication Error Detection Time**

Determines the detection time to trigger the communication error. (This function is disabled when set to 0)

No.	Name	Setting Range	Default
E6-09	Communication Fault Detection time	0.0 to 10.0 s	0.0 s

■ **E6-10 Transmit Wait Time**

Sets the wait time between the drive receiving data and responding data.

No.	Name	Setting Range	Default
E6-10	Transmit Wait Time	5 to 65 ms	5 ms

■ **E6-11 Drive Operation During Communication Error**

No.	Name	Setting Range	Default
E6-11	Drive Operation During Communication Error	0, 1	0

0 : Display CE Alarm Only

The drive continues operation.

1 : Display CE Fault

The drive coasts to stop.

6.7 Group P, Protections

P1 Motor Protection Function

■ P1-00 Motor Protection Function Selection

The drive has an overload protection using an electrothermal relay. The overload tolerance is calculated by the output current, output frequency and thermal motor characteristics. When the motor overload is detected, an oL1 (Motor Overload) fault shuts off the drive output.

Set this parameter according to the motor being used.

No.	Name	Setting Range	Default
P1-00	Motor Protection Function Selection	0 to 5	0

Note:

1. When the motor protection is enabled (P1-00≠0), an oL1 alarm can be output via the multi-function output terminal assigned (E2-00 = 26). When the motor overload level exceeds 90% of the oL1 detection level, the output terminal closes.
2. When the drive is running a single motor, set a value other than 0 to enable this function. An external thermal relay is not required.

0 : Disabled (Motor Overload Protection Disabled)

Sets 0 (disabled) when using one drive to run more than one motor. Install an overload relay between the drive and each motor as illustrated in Figure 6.71.

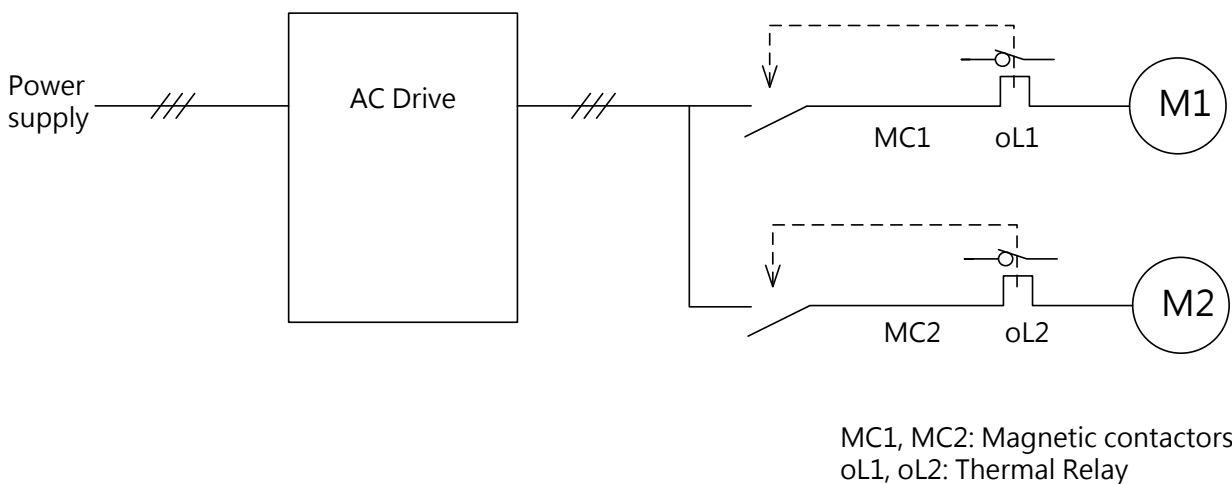
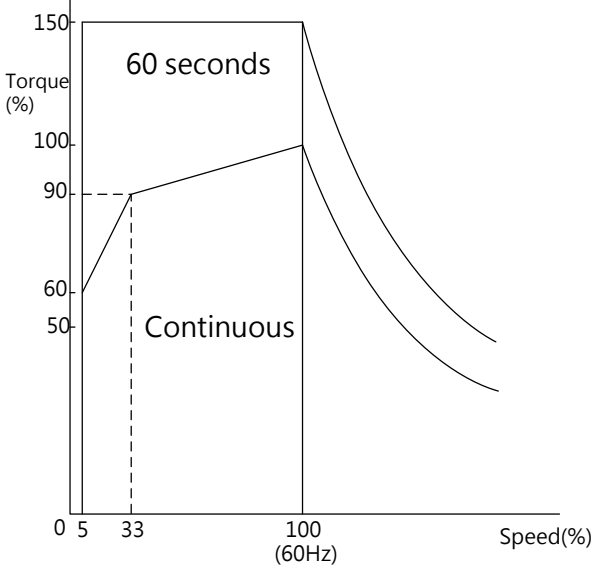

Figure 6.71 Protection Circuit for Multiple Motors

NOTICE: When a drive is running more than one motor or a motor with a rated current higher than other standard motors (such as a submersible motor), the thermal protection cannot be provided. Set 0 to P1-00 to disable this function and install an individual motor thermal relay for each motor. MC1 and MC1 cannot be switch on or off during run.

1 : General-Purpose Motor (Standard Motor)

The motor is self-cooled so the overload tolerance falls when the motor speed is decreased. The Electrothermal relay trigger level changes according to the motor overload characteristics to protect the motor from overheat throughout the entire speed range.

Overload Tolerance	Cooling Ability	Overload Characteristics (when motor load is 150%)
	<p>Motor to operate from line power. Motor cooling is most effective when running at 50/60 Hz</p>	<p>Running continuously at below 50/60 Hz triggers an oL1 fault. A fault is output and the motor will coast to stop.</p>

2 : Drive Dedicated Motor (Constant Torque Range 1 : 10)

The motor is allowed to run with 100% load from 10% to 100% speed. When the motor runs slower with 100% load, an overload fault will be triggered.

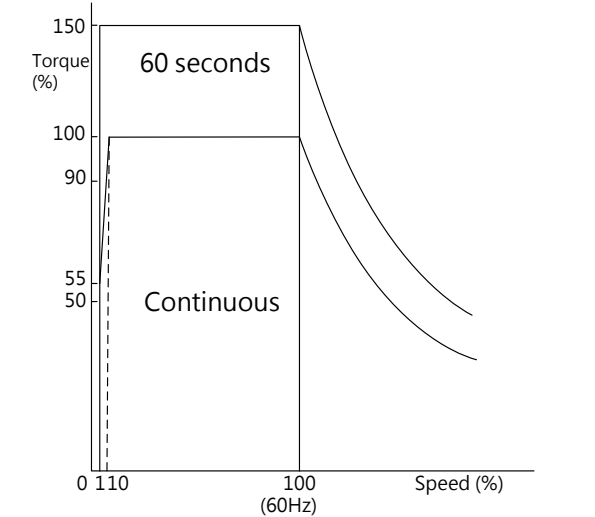
Overload Tolerance	Cooling Ability	Overload Characteristics (when motor load is 100%)
	<p>Motor cools itself effectively even at low speeds (about 6 Hz)</p>	<p>Continuous run from 6 Hz to 60 Hz</p>

3 : Vector Motor (Constant Torque Range 1 : 100)

The motor is allowed to run with 100% load from 1% to 100% speed. When the motor runs slower with 100% load, an overload fault will be triggered.

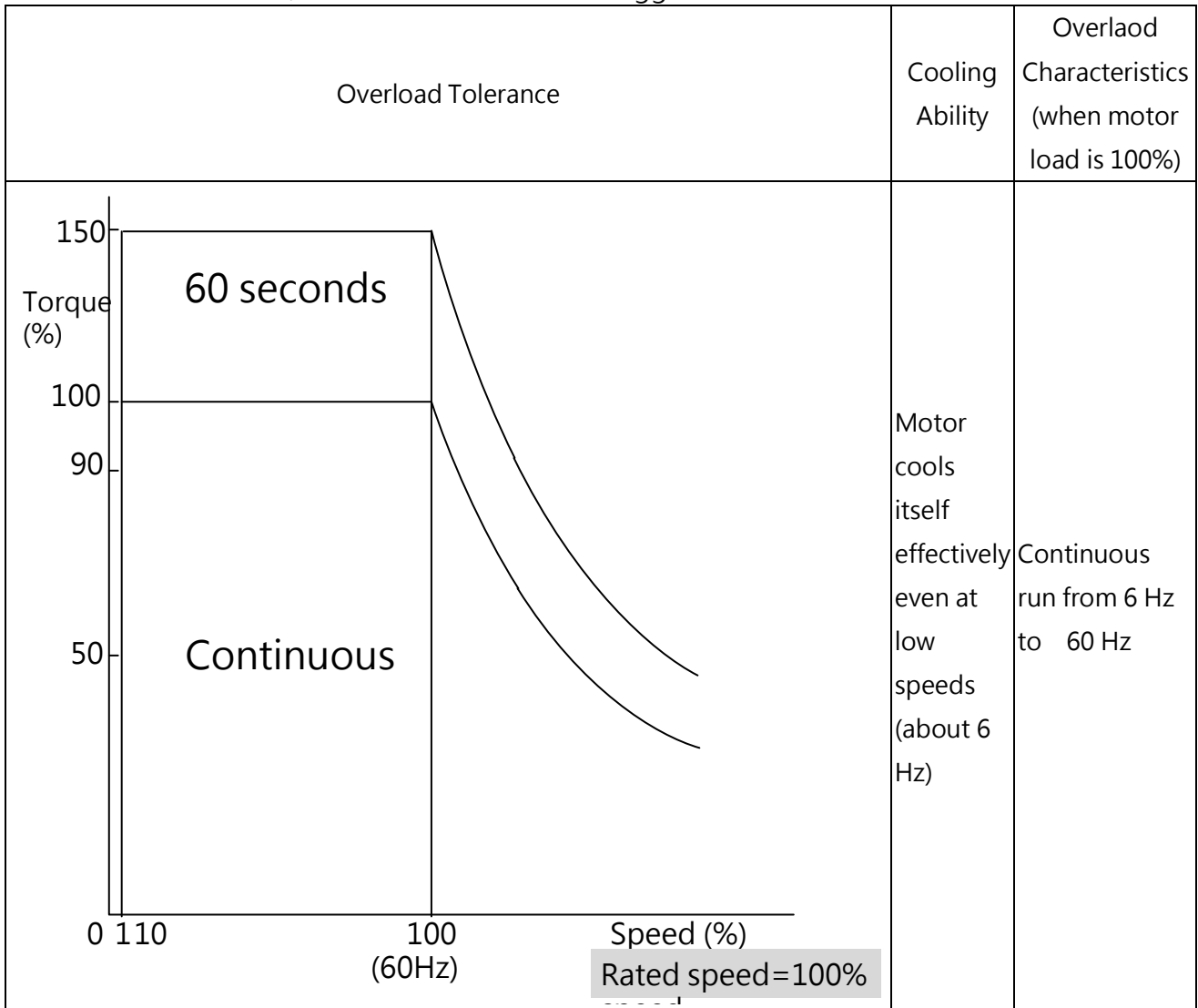

■ P1-01 Motor Overload Protection Time

Sets the time for the drive to shut down on motor overload. (Normal this parameter does not require adjustment. However, enter the time the motor can withstand operation in a hot motor overload condition if the motor overload tolerance data is confirmed by the motor manufacturer.)

No.	Name	Setting Range	Default
P1-01	Motor Overload Protection Time	0.1 to 5.0 min	1.0 min

The default is operation with 150% overload tolerance for one minute in a hot start.

The electrothermal protection operation time is illustrated in the following figure. Motor overload protection operates in the range between a cold start and a hot start.

(P1-01 = 1 minute, 60 Hz speed, general-purpose motor)

- Cold start: The motor protection operation time responds to an overload situation which is suddenly reached when starting a stationary motor.
- Hot start: The motor protection operation time responds to an overload situation which occurs when the motor was running continuously at its rated current.

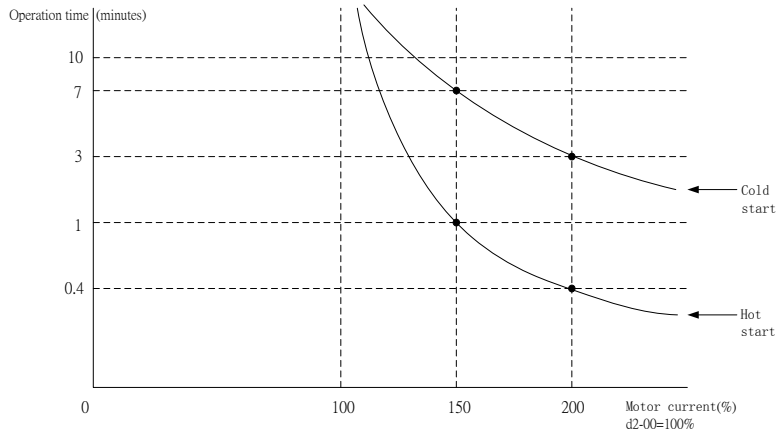

Figure 6.72 Motor Protection Operation Time

P2 Momentary Power Loss

■ P2-00 Momentary Power Loss Operation Selection

Selects the drive operation when a momentary power loss occurs (the main circuit DC voltage falls below the P2-03 level). The drive can automatically return to the operation it was performing before the power loss.

No.	Name	Setting Range	Default
P2-00	Momentary Power Loss Operation Selection	0 to 1	0

0 : Disabled (Default)

When the power supply falls below the P2-03 (Uv Detection Level) value for 10ms, a Uv (Undervoltage) fault will be triggered to shut off the drive output and the motor coasts to stop.

1 : Recover if CPU Has Power

When the CPU of the drive is powered after a momentary power loss, the drive will resume the operation. The KEB function will not perform even if KEB is enabled.

■ P2-01 Minimum Baseblock (bb) Time

Sets the minimum baseblock time when power is restored right after a momentary power loss.

This determines the time the drive waits for the residual voltage in the motor to dissipate. Increase this value if overcurrent or overvoltage occurs at the beginning of Speed Search and DC Braking.

No.	Name	Setting Range	Default
P2-01	P2-01 Minimum Baseblock (bb) Time	0.1 to 5.0 s	Determined by o2-03

■ P2-03 Uv (Undervoltage) Detection Level

Sets the voltage level of undervoltage detection or KEB function activation. Normally this parameter does not require any change.

No.	Name	Setting Range	Default
P2-03	Uv (Under voltage) Detection Level	150 to 210 V <1>	Determined by d1-00 and o2-03<2>

<1> This is the value for 200V. Double this value for 400V.

<2> The default setting for 400 V drives depends on whether the drive input voltage is higher or lower than 400V.

Note:

1. When setting a value lower than the default, install an AC reactor option on the drive input side to prevent damage to the drive parts.

■ P2-05 Acceleration Time after Uv (Undervoltage)

Sets the time to reaccelerate to the set frequency command after power loss.

When set to 0.0 s, the drive will accelerate to the previously active frequency according to the active acceleration time set by any of C1-00, C1-02.

No.	Name	Setting Range	Default
P2-05	Acceleration Time after Uv	0.0 to 6000 s <1>	0.3 s

■ P2-10 Automatic voltage regulation

No.	Name	Setting Range	Default
P2-10	Automatic voltage regulation	0, 1	1

0 : Disabled

1 : Enabled

P3 Stall Prevention

When the load is too heavy or the deceleration time is too short, the motor may not be able to keep up with the frequency command and slips. The regenerative power from the power will then exceed the tolerance of main circuit capacitor and trigger an ov (Overvoltage) fault to stop the drive. This process is called "stall" . When a motor stalls, it cannot be accelerated or decelerated. The Stall Prevention Function prevents the motor from stalling and while allowing

the motor to keep up with the desired speed without changing the acceleration or deceleration times. This function can be set separately for acceleration, operating at constant speeds, and deceleration.

■ **P3- 00 Stall Prevention during Acceleration**

Sets the method to prevent the motor being stopped by oC(Overcurrent), oL1 (Motor Overload) or oL2 (Drive Overload) fault.

No.	Name	Setting Range	Default
P3-00	Stall Prevention during Acceleration	0 to 1	1

0 : Disabled

The Stall Prevention function is not provided during acceleration. If the acceleration time is too short, the motor might not be able to be accelerated causing an overload fault and stop.

1 : Enabled

The Stall Prevention is enabled during acceleration. The operation is determined by the selected control method.

- V/F Control / Open-Loop Vector Control

Acceleration stops when the output current exceeds the value set in P3-01. Acceleration continues when the output current drops 15% below the value set in P3-01. The Stall Prevention level is automatically decreased in the constant power range. Refer to P3-02 (Stall Prevention Limit during Acceleration) for details..

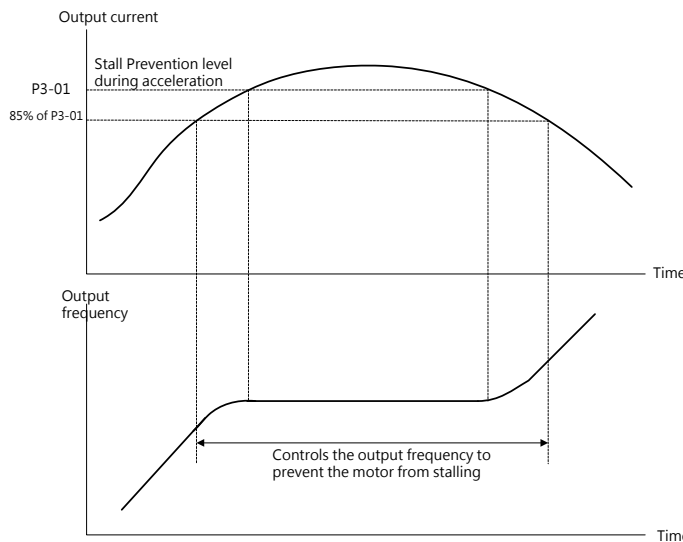

Figure 6.78 Stall Prevention during Acceleration for IM motors

■ **P3-01 Stall Prevention Level during Acceleration**

Sets the output current level to activate the Stall Prevention function during acceleration.

No.	Name	Setting Range	Default
P3-01	Stall Prevention Level during Acceleration	0 to 150% <1>	<1>

- When the motor rating is smaller than the drive rating, using the default to run the motor could cause motor to stall. If the stall occurs, set a smaller to this parameter.
- Set P3-02 as well when running the motor in the constant power range.

■ P3-02 Stall Prevention Limit during Acceleration

when running the motor in the constant power range, the P3-01 value will be automatically reduced.

Sets the lower limit of Stall Prevention in the constant power range as a percentage of the drive rated output current.

No.	Name	Setting Range	Default
P3-02	Stall Prevention Limit during Acceleration	0 to 100%	50%

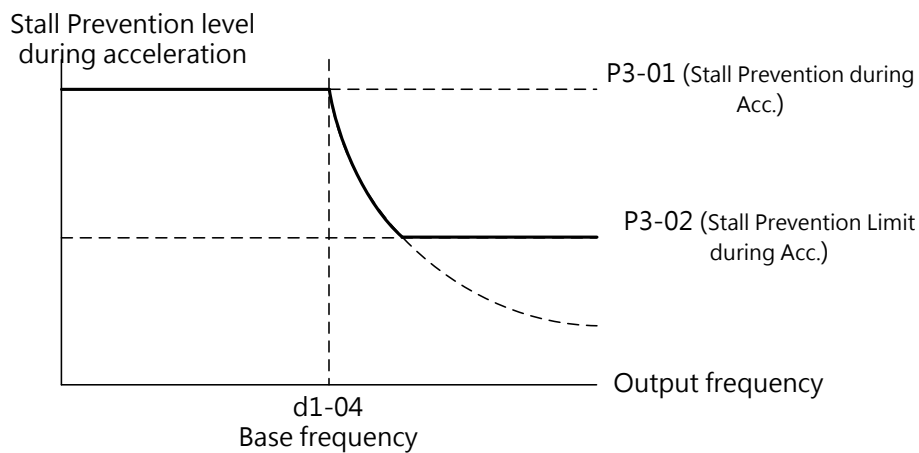

Figure 6.80 Stall Prevention Level during Acceleration

■ P3-03 Stall Prevention during Deceleration

The Stall Prevention function during deceleration controls the deceleration base on the main circuit DC voltage, and use high inertia or rapid deceleration to prevent an ov (Overvoltage) fault.

No.	Name	Setting Range	Default
P3-03	Stall Prevention during Deceleration	0 to 1	1

0 : Disabled

The drive decelerates according to the set deceleration time. With high inertia loads or rapid deceleration, an ov (Overvoltage) fault could be triggered. Therefore use braking options or set this parameter to 1.

1 : Enabled

When the main circuit voltage exceeds the stall Prevention level during acceleration, the deceleration pauses and hold the frequency. When the main circuit voltage falls below the Stall Prevention level, the drive continues to decelerate using the set deceleration time. Stall Prevention might be triggered repeatedly to prevent an overvoltage fault.

Stall Prevention might lengthen the total deceleration time until a completely stop. Therefore install a braking option for applications such as conveyors.

The Stall Prevention function is illustrated below.

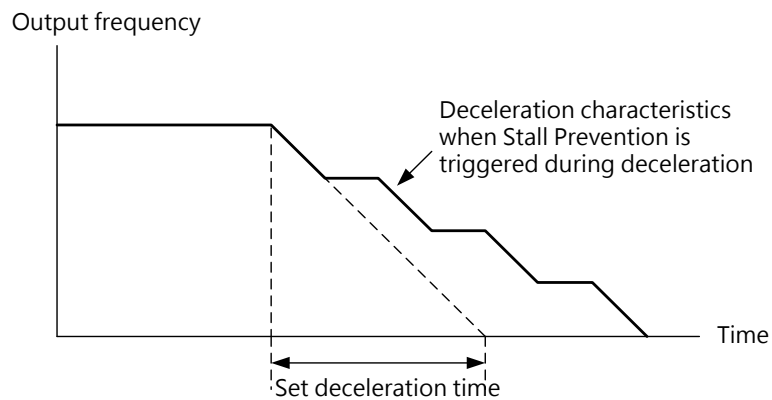

Figure 6.81 Stall Prevention during Deceleration Operation

■ P3-04 Stall Prevention Level during Deceleration

Sets the voltage level to activate the Stall Prevention function during deceleration.

No.	Name	Setting Range	Default
P3-04	Stall Prevention Level during Deceleration	330V to 410V <1>	395V <1>

When the regenerative power boosts the main circuit DC voltage higher than the value set to this parameter during deceleration, the drive performs Stall Prevention during deceleration to prevent an oV (Overvoltage) fault. Lower this value if the load is too heavy which causes a rapid regenerative power increase.

<1> This value is for a 200 V AC drive. Double this value for a 400 V AC drive.

■ P3-05 Stall Prevention during Run

Stall Prevention during run prevents an oL1 (Motor Overload) fault when the motor is running at constant speed.

No.	Name	Setting Range	Default
P3-05	Stall Prevention during Run	0 to 2	1

Note:

1. Available in Open-Loop V/F Control, Closed-Loop V/F Control and PM Open-Loop Vector Control control methods.
2. Disable when the output frequency is below 6 Hz regardless the P3-05 and P3-06 settings.

0 : Disabled

The drive runs at the set frequency command. A heavy load might cause the motor too stall and triggered an oC (Overcurrent) or oL1 (Motor Overload) to stop the motor.

1 : Enabled (Deceleration Time 1)

When the drive output current exceeds the P3-06 (Stall Prevention Level during Run) level, the deceleration time C1-01, C1-03, C1-05 or C1-07 will be used to decelerate. When the drive output current falls below the value of P3-06 minus 2% for 100 ms, the drive accelerates back to the frequency command at the active acceleration time.

2 : Enabled (Deceleration Time 2)

Same as P3-05 = 1 except the drive decelerates using the C1-03 deceleration time.

■ P3-06 Stall Prevention Level during Run

Sets the current level to activate the Stall Prevention function during run.

No.	Name	Setting Range	Default
P3-06	Stall Prevention Level during Run	30 to 150%	150%

□ Using Analog Input to Change Stall Prevention Level during Run

If E3-□□= 7 (Stall Prevention Level during Run) is set, this value can be changed via input terminal A1.

The Stall Prevention level during run is determined by the smaller value of the P3-06 setting or the input via terminal A1.

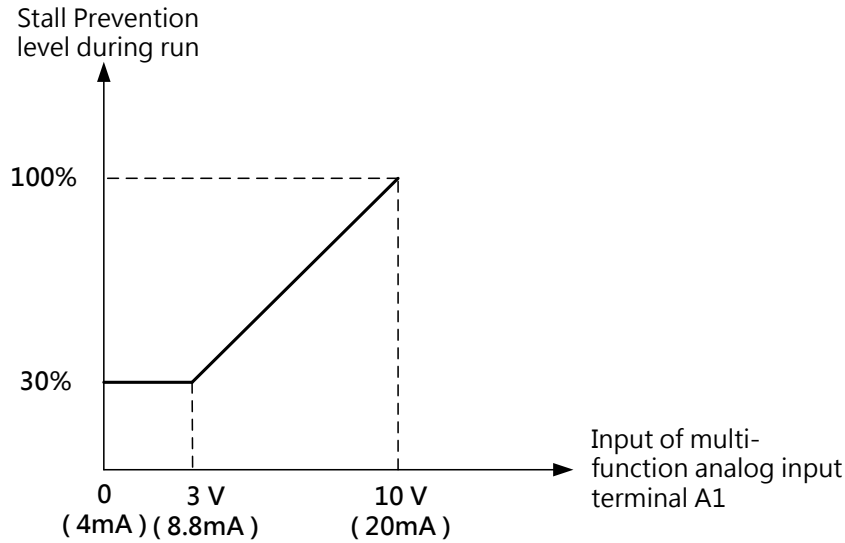

Figure 6.82 Using Analog Input to Change Stall Prevention Level during Run

■ P3-07 to P3-10 Retain

P4 Frequency Detection

P4 parameters set the frequency agree and frequency detection to the assigned multi-function output terminal.

■ P4-00 / P4-01 Frequency Detection Level / Width

P4-00 sets the detection level for the multi-function output terminal assigned to E2-□□ = 2 (Frequency Agree), E2-□□=3 (User-Defined Frequency Agree), E2-□□=16 (Frequency Detection 1) or E2-□□=17 (Frequency Detection 2).

P4-01 Sets the detection width for the multi-function output terminal.

No.	Name	Setting Range	Default
P4-00	Frequency Detection Level	0.0 to <1>	30.0 Hz
P4-01	Frequency Detection Width	0.1 to 25.5 Hz	2.0 Hz

<1> The upper limit is determined by the values set to d1-02 (Maximum Output Frequency), d1-13 (Motor 2 Maximum Output Frequency) and L2-00 (Frequency Command Upper Limit).

■ P4-02 Frequency Command Loss Detection Selection

The drive can detect a frequency command loss from terminal A1 or A2. When the frequency command falls below 90% of the command within the time set in P4-04, the frequency command loss will be detected.

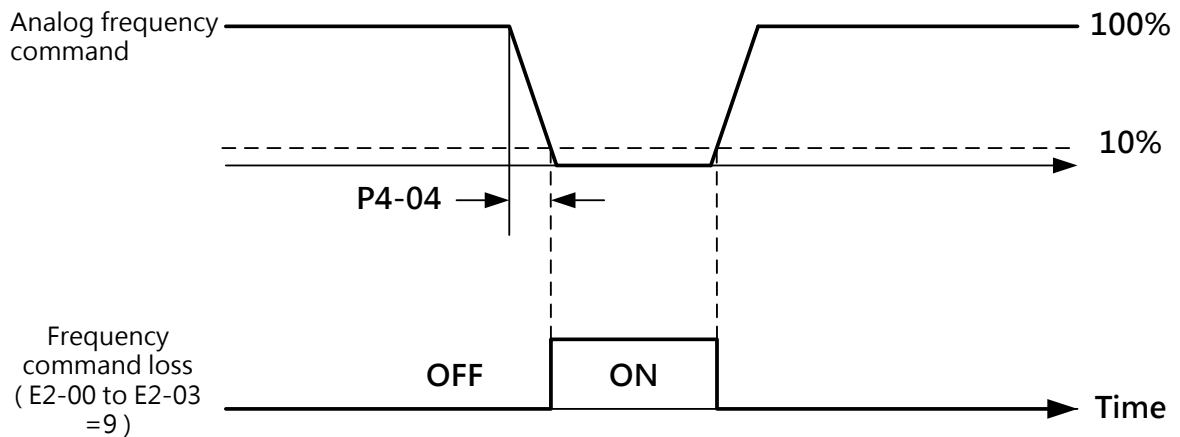

Figure 6.83 Frequency Command Loss Detection Operation

This parameter sets the drive operation when a frequency command loss is detected. Set E2-00 to E2-03 to 9 (Frequency Command Loss) for the output terminal to trigger when frequency command loss occurs.

No.	Name	Setting Range	Default
P4-02	Frequency Command Loss Detection Selection	0,1	0

0 : Drive stop

The drive runs according to the frequency command.

1 : Continue operation according to the setting in P4-03.

The drive continues to run at the frequency set to P4-03 during frequency command loss. When the frequency command is restored, the operation will be continued with the frequency command.

■ P4-03 Frequency Command at Frequency Command Loss

Sets the frequency command level at which the drive runs when detecting a frequency command loss and when L4-02 is set to 1. Sets the value as a percentage of the maximum output frequency set in d1-02.

No.	Name	Setting Range	Default
P4-03	Frequency Command at Frequency Command Loss	0.0 to 100.0%	80.0 %

■ P4-04 Frequency Command Loss Detection Time

When the frequency command falls below 90% of the command within this detection time, the frequency command loss will be detected.

No.	Name	Setting Range	Default
P4-04	Frequency Command Loss Detection Time	20 to 400ms	20ms

P5 Fault Restart

Fault Restart tries to automatically restart the motor and continue operation to prevent the motor from stopping when a fault is detected.

The drive diagnoses itself and continues operation when a fault is detected during run. If the self-diagnosis is successful to clear the fault, the drive restarts automatically with Speed Search. Refer to b3 (Speed Search) for details.

Note:

1. The Run command (forward/ reverse) will automatically be removed when the sequency control circuit makes the fault shut off the drive output.
2. When the Run command is removed, the drive diagnoses itself, attempts to clear the fault and restart.

WARNING! Do not perform Fault Restart in applications such as lifting, which could cause the machine to drop the load.

Fault Restart can be performed when the following faults occur.

Fault	Fault Name	Fault	Fault Name
GF	Ground Fault	OL2	Drive Overload
OVA	Overvoltage (Acceleration)	Ot1	Overload Detection 1
OVD	Overvoltage (Deceleration)	PF	Input Phase Loss
OVC	Overvoltage (Constant Speed)	LF1	Output Phase Loss
oCA	Overcurrent (Acceleration)		
oCD	Overcurrent (Deceleration)		
oCC	Overcurrent (Constant Speed)		
OH	Heatsink Overheat		
OL1	Motor Overload		

Set Fault Restart in P5-00 to P5-03.

Set E2-00 to E2-03 to 14 (Fault Start) to output the signal to an external devices.

■ P5-00 Number of Auto Restart Attempts

Sets the number of times to automatically attempt to restart the drive when detecting the fault listed above. The drive will stop operation when the restart attempts reach the number set in this parameter. Clear the cause of the fault manually and restart the drive.

The number of auto restart attempts is reset to 0 in the following situations.

- The drive runs normally for 10 minutes after a fault restart.
- A fault is reset manually after the protection function is triggered.
- The power supply is cycled.

No.	Name	Setting Range	Default
-----	------	---------------	---------

P5-00	Number of Auto Restart Attempts	0 to 10	0
-------	---------------------------------	---------	---

■ **P5- 01 Auto Restart Fault Output Operation**

Enables or disables the fault output via E2-□□= 11 (Fault) during Fault Restart.

No.	Name	Setting Range	Default
P5-01	Auto Restart Fault Output Operation	0, 1	0

0 : Fault Output Disabled

1 : Fault Output Enabled

■ **P5-02 Fault Restart Interval Time**

Sets the amount of time between restart attempts.

No.	Name	Setting Range	Default
P5-02	Fault Restart Interval Time	0.5 to 600.0 s	10.0 s

P6 Overtorque/ Undertorque Detection

When the load is too heavy (overload) or suddenly drops (undertorque), the drive will output a torque detection signal to the multi-function output terminal (Relay 1, Relay 2, D1-DC or D2-DC). The torque detection function is set by P6 parameters.

CAUTION! When overtorque occurs, the drive may trigger the fault to stop the motor. To prevent the drive from stopping, use torque detection to indicate an overload situation before the fault is triggered. Similar situations also apply to undertorque. Use undertorque detection to find out application problems such as torn belts, a pump shutting off and etc.

E2-00 Setting	Name
18	Overvoltage/ Undervoltage Detection 1 (normal open)
20	Overvoltage/ Undervoltage Detection 2 (normal open)

Overtorque and undertorque operations are illustrated in Figure 6.84 and Figure 6.85.

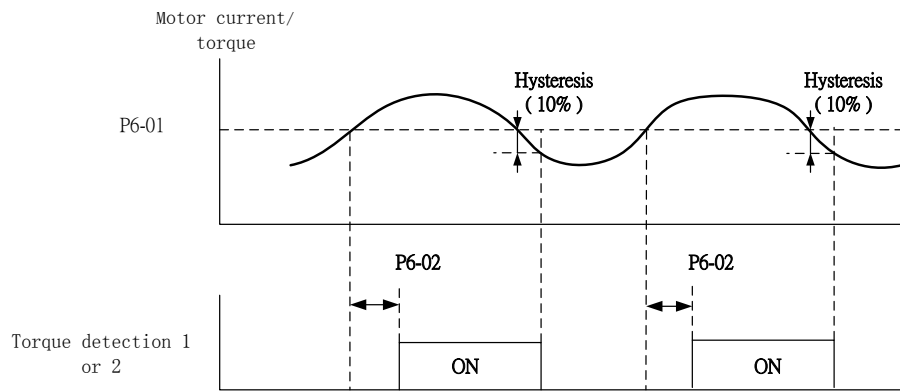

Figure 6.84 Overtorque Detection Operation

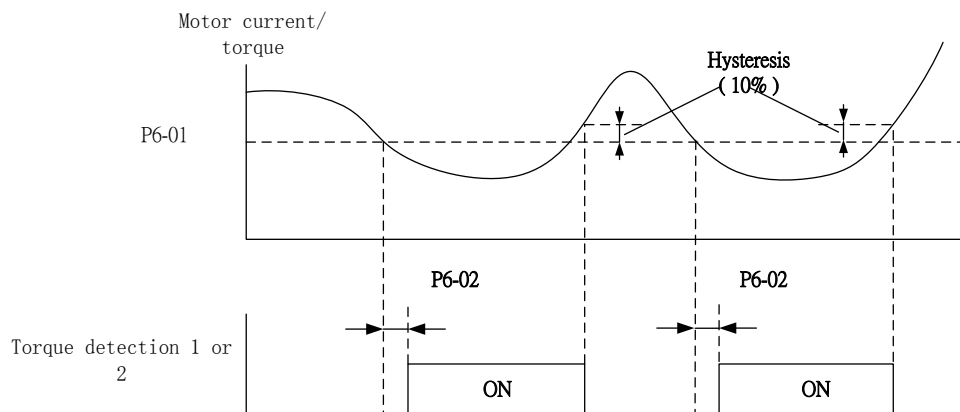

Figure 6.85 Undertorque Detection Operation

Note:

1. A 10% of the drive rated current and motor rated torque are used for the torque detection function.
2. Overtorque/ undertorque detection is set as a percentage of the drive rated output current in Open-Loop V/F Control, Closed-Loop V/F Control. Overtorque/ undertorque detection is set as a percentage of the motor rated torque in Open-Loop Vector Control, Closed-Loop Vector Control.

■ P6-00 Overtorque/ Undertorque Detection Selection 1

Sets the operation when the motor current or torque exceeds the P6-01 level for longer than the time set to P6-02.

No.	Name	Setting Range	Default
P6-00	Overtorque/ Undertorque Detection Selection 1	0 to 8	0

0 : Disabled

1 : Overtorque Alarm at Speed Agree

Overtorque detection is active only when the output frequency is the same as the frequency command. No detection during acceleration or deceleration. The drive continues to run after an ot1 (Overtorque Detection 1) alarm is triggered.

2 : Overtorque Alarm at Run

Overtorque detection is active when the Run command is active. The drive continues to run after an ot1 (Overtorque Detection 1) alarm is triggered.

3 : Overtorque Fault at Speed Agree

Overtorque detection is active only when the output frequency is the same as the frequency command. No detection during acceleration or deceleration. The drive stops operation after an ot1 (Overtorque Detection 1) fault is triggered.

4 : Overtorque Fault at Run

Overtorque detection is active when the Run command is active. The drive stops operation after an ot1 (Overtorque Detection 1) fault is triggered.

5 : Undertorque Alarm at Speed Agree

Undertorque detection is active only when the output frequency is the same as the frequency command. No detection during acceleration or deceleration. The drive continues to run after an Ut1 (Undertorque Detection 1) alarm is triggered.

6 : Undertorque Alarm at Run

Undertorque detection is active when the Run command is active. The drive continues to run after an Ut1 (Undertorque Detection 1) alarm is triggered.

7 : Undertorque Fault at Speed Agree

Undertorque detection is active only when the output frequency is the same as the frequency command. No detection during acceleration or deceleration. The drive stops operation after an Ut1 (Undertorque Detection 1) fault is triggered.

8 : Undertorque Fault at Run

Undertorque detection is active when the Run command is active. The drive stops operation after an Ut1 (Overtorque Detection 1) fault is triggered.

■ P6-01 Overtorque/ Undertorque Detection Level 1

Sets the level for overtorque/undertorque detection

Overtorque/ undertorque detection is set as a percentage of the drive rated output current in Open-Loop V/F Control, Closed-Loop V/F Control, and PM Open-Loop Vector Control control methods. Overtorque/ undertorque detection is set as a percentage of the motor rated torque in Open-Loop Vector Control, Closed-Loop Vector Control, and PM Closed-Loop Vector Control control methods.

No.	Name	Setting Range	Default
-----	------	---------------	---------

P6-01	Overtorque/ Undertorque Detection Level 1	0 to 300%	150%
-------	---	-----------	------

Note: This level can be set by the analog input terminal assigned to E3-□□=11. The analog input overrides the setting in this parameter. However P6-04 (Overtorque/ Undertorque Detection Level 2) cannot be set by the analog input terminal.

■ P6-02 Overtorque/ Undertorque Detection Time 1

Sets the time for overtorque/undertorque detection 1.

No.	Name	Setting Range	Default
P6-02	Overtorque/ Undertorque Detection Time 1	0.0 to 10.0 s	0.1 s

P7 Drive Protection

■ P7-00 Input Phase Loss Protection

Enables or disables the input phase loss detection.

No.	Name	Setting Range	Default
P7-00	Input Phase Loss Protection	0, 1	0

0 : Disabled

1 : Enabled

When a power supply voltage is imbalance or main circuit capacitor is weakening, the input phase loss will be detected and a PF (Phase Loss) fault will be triggered.

The detection is disabled in the following situations.

- The drive is decelerating
- No Run command is entered
- Output current is below or equal to 30% of the drive rated current

■ P7-01 Output Phase Loss Protection

Sets the output phase loss detection. The output phase loss will be detected when the output current is less than 5% of the drive rated output current.

Note:

1. If the motor rated current is too small compared with the drive rating, output phase loss detection may be mistakenly triggered. Set P7-01 to 0 (disabled) in this situation .

No.	Name	Setting Range	Default
P7-01	Output Phase Loss Protection	0 to 2	0

0 : Disabled

1 : Enabled when One Phase is Lost

A LF1 (Output Phase Loss) fault is triggered when one output phase is lost. The drive output is cut off and the motor coasts to stop.

2 : Enabled when Two Phases are Lost

A LF1 (Output Phase Loss) fault is triggered when more than one output phases are lost. The drive output is cut off and the motor coasts to stop.

■ P7-02 Output Ground Fault Detection

Enables or disables the output ground fault detection.

No.	Name	Setting Range	Default <1>
P7-02	Output Ground Fault Detection	0, 1	0

0 : Disabled

No ground fault detection.

1 : Enabled

A GF (Ground Fault) fault is triggered when a ground short circuit or high leakage current occurs in one or two output phases.

■ P7-03 Heatsink Cooling Fan Operation

Sets the heatsink cooling fan operation.

No.	Name	Setting Range	Default
P7-03	Heatsink Cooling Fan Operation	0 to 2	0

0 : Enabled when drive is running

The fan is switched on when a Run command is entered and switched off with the wait time set to P7-04 after removing the Run command. This setting can be used to extend the fan lifetime.

1 : Enabled when power supply is On

The fan operates as long as the power is supplied to the AC drive.

2 : Enabled when the heatsink temperature reaches the limit.

■ P7-04 Heatsink Cooling Fan Off-Delay Time

Sets the cooling fan off-delay time when P7-03=0 that the drive waits to disabled the cooling fan after run command is released.

No.	Name	Setting Range	Default
P7-04	Heatsink Cooling Fan Off-Delay Time	0 to 300 s	60 s

■ P7-05 Ambient Temperature Setting

Sets the ambient temperature. This automatically decreases the drive rated current when the ambient temperature is higher than the temperature specified in drive specifications. The installation method is required to be set in P7-12.

No.	Name	Setting Range	Default
P7-05	Ambient Temperature Setting	-10 to 50°	40°

■ P7-12 Installation Method Selection

Selects the installation type. The drive overload detection limit will be changed according to the selection.

Note:

1. This value cannot be reset by A1-03 (Reset).
2. The default value is preset to the appropriate value. Do not change this value unless using side-by-side installation or mounting the drive with the heatsink outside the cabinet.

No.	Name	Setting Range	Default <1> <2> <3>
P7-12	Installation Method Selection	0 to 2	0

0 : IP20 Enclosure in a Cabinet

Select this when the IP20 enclosure drive is installed in a cabinet with at least 30 mm room to the next drive or a cabinet wall.

1 : Side-by-Side Mounting

Select this when the drive is mounted side-by-side with 2 mm to 29 mm room to the next drive.

6.8 Group o, Keypad Function Settings

o1 Display Setting

■ o1- 00 Frequency Command Setting/Display

o1-00 used to select the frequency command unit and monitor values. o1-00 = 3 and under

o1-02 and o1-03, the unit can be set to any ◦

No.	Name	Setting Range	Default
o1-00	Frequency Command Setting/Display	0 ~ 2	0

0 : Use units of 0.01Hz

1 : Use units of 0.01% (100% as maximum output frequency)

group of motor poles)

■ o1- 01 Setting Unit V / f characteristic frequency-dependent parameters

Select V / f curve frequency setting parameter (d1-02,04,06,08,10) setting unit. When o1-01 = 1, in order for the Poles d2-03 to min-1 units can be set

No.	Name	Setting Range	Default
o1-01	Setting Unit V / f characteristic frequency-dependent parameters	0,1	0

0 : Use units of Hz

1 : Use units of min-1

■ o1- 02 User-Defined Frequency Command Setting/Display

Setpoint at maximum output frequency to be displayed ◦

No.	Name	Setting Range	Default
o1-02	User-Defined Frequency Command Setting/Display	1 ~ 9999	Setting as o1-00

■ o1- 03 Frequency Command Setting/Display Decimal Places

Setting frequency command setting/display decimal places

No.	Name	Setting Range	Default
o1-03	Frequency Command Setting/Display Decimal Places	0 ~ 3	Setting as o1-00

o2 Multi-Function Selection

o2 parameters determine the functions assigned to the keys on the keypad.

■ o2-01 STOP Key Function Selection

Determines if the STOP key on the keypad will stop the drive when Remote is selected as the command source.

No.	Name	Setting Range	Default
o2-01	STOP Key Function Selection	0, 1	1

0 : Disabled

1 : Enabled

The STOP key always stops drive operation even if the command source is not set to the keypad. To restart the drive, cycle the Run command if the drive has been stopped by pressing the STOP key.

■ o2-02 Retain

■ o2-03 Drive Capacity Selection

Set this parameter after replacing the terminal block or drive modules.

CAUTION! An incorrect o2- 03 setting may cause the drive performance to suffer and drive damage.

No.	Name	Setting Range	Default
o2-03	Drive Capacity Selection	<1>	Determined by drive capacity

<1> Table for the setting range

Rating (kW) (200V series)	0.25	0.4	0.75	1.5	2.2
o2-03 Setting	0	1	2	3	4
Rating (kW) (400V Series)	0.25	0.4	0.75	1.5	2.2
o2-03 Setting	32	33	34	35	36

■ o2-04 ENTER Key Function During Frequency Command Setting

Determines whether the ENTER key is required to be pressed after changing the frequency command using the keypad in Local mode.

No.	Name	Setting Range	Default
o2-04	ENTER Key Function During Frequency Command Setting	0,1	0

0 : ENTER Key Required

The ENTER key is required to be pressed to trigger the frequency command.

1 : ENTER Key Not Required

When entering a frequency command, the output frequency changes immediately by UP or DOWN key without pressing ENTER. The frequency command will be saved 5 seconds after it is changed by pressing the UP or DOWN key.

■ o2-05 Retain

■ o2-06 Operation Direction at Power Up when Using Keypad

Determines the motor rotating direction after the drive power up and the Run command is entered from the digital operator.

Note: This parameter is provided only in Local mode when b1-01=0 or b1-08 = 0 (Keypad).

No.	Name	Setting Range	Default
o2-06	Operation Direction at Power Up when Using Keypad	0, 1	0

0 : Forward

1 : Reverse

o3 Retain

o4 Maintenance Settings

■ o4-00 Cumulative Operation Time Setting

Sets the initial value by 1 hours to start keeping track of cumulative operation time. The cumulative operation time can be viewed in U3-00.

Note: A setting of 20 will set the cumulative operation time to 200h and the monitor will display 200h in U3-00.

No.	Name	Setting Range	Default
o4-00	Cumulative Operation Time Setting	0 to 9999 h	0h

■ o4-01 Cumulative Operation Time Selection

Selects the conditions in which the drive keeps track of the cumulative operation time.

No.	Name	Setting Range	Default
o4-01	Cumulative Operation Time Selection	0, 1	0

0 : Time of Power On

Keeps track of time from the power up to power cutoff.

1 : Time of Run

Keeps track of time when the output voltage is active.

■ o4-06 U2 Reset Setting

Resets the data for U2-□□ (Fault Information) as this data will not be reset by A1-03 (Reset).

No.	Name	Setting Range	Default
o4-06	U2 Reset Setting	0,1	0

0 : No Action

The data for the U2-□□ (Fault Information) monitor will not be reset.

1 : Enabled

Resets the data for the U2-□□ (Fault Information) monitor. Set this value to 1 and press ENTER will clear all the fault information to 0.

■ o4- 07 to o4-08 Retain

6.9 Group t, Auto-Tuning

t1 IM Motor Auto-Tuning

t1 parameters set the data for IM motor Auto-Tuning

Note: When running variable speed motors or vector motors, the voltage or frequency may be lower than general-purpose motors. Therefore set the motor data according to the motor nameplate and perform Auto-Tuning. After that, change the maximum output frequency in d1-02.

■ t1-01 Auto-Tuning Method Selection

Selects the method of Auto-Tuning..

No.	Name	Setting Range	Default
t1-01	Auto-Tuning Method Selection	0,1,2	0

0 : Rotational Auto-Tuning

1 : Stationary Auto-Tuning 1

■ t1-02 Motor Output Power

Sets the motor rated output power in kW units.

No.	Name	Setting Range	Default
t1-02	Motor Output Power	0.00 to 650.0 kW	Determined by o2-03

Note:

1. The maximum motor rating the drive can run changes depending on the A1-06 (ND/HD Selection) setting.
2. 1HP (Horse Power) = 0.746kW

■ t1-03 Motor Rated Voltage

Sets the motor rated voltage according to the motor nameplate. If the motor is operating above base speed, enter the voltage base speed here.

Variable speed motors and vector motors may have lower voltage or frequency than the general-purpose ones. Therefore make sure the data entered matches the motor test report. Enter the no-load voltage in this parameter for better control precision. If the motor test report or the nameplate data is not available, set approximately 90% of the motor rated voltage.

If the drive input voltage is low, set approximately 90% of the drive input voltage. This may increase the output current and reduce the overload margin.

No.	Name	Setting Range	Default
t1-03	Motor Rated Voltage	0.0 to 255.5 V <1>	200.0 V <1>

<1> This value is for a 200 V drive. Double this value for a 400 V drive.

■ t1-04 Motor Rated Current

Sets the motor rated current according to the motor nameplate. Set the motor rated current between 50% and 100% of the drive rated current for optimal performance. Enter the current at the motor base speed.

No.	Name	Setting Range	Default
t1-04	Motor Rated Current	10 to 200% of drive rated current	d2-10 (d2-21)

Note: The setting range changes depending on the settings of o2-03 (Drive Capacity Selection)and A1-06(ND/HD Selection)的.

■ t1-05 Motor Base Frequency

Sets the motor base frequency according to the motor nameplate. Enter the maximum frequency to d1-02 (d1-13 for motor 2) after Auto-Tuning if a motor with an extended speed range is used or the motor is used in the field weakening area.

No.	Name	Setting Range	Default
t1-05	Motor Base Frequency	0.0 to 400.0 Hz	50.0

■ t1-06 Number of Motor Poles

Sets the number of motor poles according to the motor nameplate.

No.	Name	Setting Range	Default
t1-06	Number of Motor Poles	2 to 48	4

■ t1-07 Motor Base Speed

Sets the motor base speed according to the motor nameplate.

No.	Name	Setting Range	Default
t1-07	Motor Base Speed	0 to 9999 rpm	1450 rpm

■ t1-09 Motor No-Load Current (Stationary Auto-Tuning)

Sets the no-load current for the motor. After the motor output power and rated current are set in t1-02 and t1-04, this parameter will automatically display the no-load current of a standard motor. The no-load current must be entered according to the motor test report.

No.	Name	Setting Range	Default
t1-09	Motor No-Load Current (Stationary Auto-Tuning)	0.0 A to (t1-04)(Max : 0 to 2999.9)	-

1. Note: The maximum motor rating the drive can run changes depending on the A1-06 (ND/HD Selection) setting. Refer to Ch 2.4 on page 15.

■ t1-10~11 Retain

■ t1-12 Motor Auto-Tuning Setting

Enables or disables Auto-Tuning when A1-02=0 to 3.

No.	Name	Setting Range	Default
t1-12	Motor Auto-Tuning Setting	0,1	0

0: Disabled

1: Enabled

Enables the motor Auto-Tuning. Set t1-12 to 1 and press the ENTER key to switch the display to the motor Auto-Tuning preparation (tUnxx). The last two letters changes depending on the selected motor (motor 1 or 2) and t1-01 setting.

Press the MENU key to cancel Auto-Tuning and leave this display or press the RUN key to start

the motor Auto-Tuning function.

The display flashes in process and shows "End" after Auto-Tuning is completed. If Auto-Tuning fails, the process stops immediately and shows "tnFxx" on the screen which "xx" indicates the problems. Refer to Chapter 8.4 Auto-Tuning for more details.

When the Auto-Tuning function is required to be controlled by the keypad, set b1-01(Run Command Selection 1) to 0 (Keypad). Otherwise Auto-Tuning cannot be started by pressing the RUN key.

6.10 Group U, Monitor Settings

U parameters views the data concerning drive operation.

Parameter	Name	Description	Unit
Group U, Monitor Settings			
U1: Status Monitors			
U1-00	Control Method	0: Open-Loop V/F Control 2: Open-Loop Vector Control	-
U1-01	Frequency Command	Displays the frequency command. (Display units are defined by o1-00)	-
U1-02	Output Frequency	Displays the output frequency. (Display units are defined by o1-00)	-
U1-03	Output Current	Displays output current.	0.01A
U1-04	Motor Speed	Displays the motor speed.	-
U1-05	Output Voltage Command	Displays the drive output voltage command.	0.1V
U1-06	Main Circuit DC Voltage	Displays the main circuit DC voltage.	0.1V
U1-07	Output Power	Displays the internal output power calculated by the drive.	0.001kW
U1-09	Input Terminal Status	Displays the status of the input terminal. U1-09=111111: The following indicate each digit from right to left. 1:Digital Input 1 (S1 enabled) 1:Digital Input 2 (S2 enabled) 1:Digital Input 3 (S3 enabled) 1:Digital Input 4 (S4 enabled) 1:Digital Input 5 (S5 enabled) 1:Digital Input 6 (S6 enabled)	-
U1-10	Output Terminal Status	Displays the status of the output terminal. U1-10=1 Multi-Function Terminal Output (terminal R1A/R1B-R1C)	-

Parameter	Name	Description	Unit
U1-11	Drive Operation Status	Displays the status of the drive operation. U1-11=11111111 The following indicate each digit from right to left. 1:During Run 1:During Zero Speed Holding 1:During Reverse 1:During Fault Reset Signal Input 1:During Speed Agree 1:Drive Ready 1:During Alarm Detection 1:During Fault Detection	-
U1-12	Terminal A1 Input Voltage	Displays the terminal A1 input voltage.	0.1%
U1-16	Software Version	Displays the software version.	-
U2: Fault Information			
U2-00	Current Fault	Displays the current fault.	-
U2-01	1 st Most Recent Fault	Displays the first most recent fault.	-
U2-02	2 nd Most Recent Fault	Displays the second most recent fault.	-
U2-03	3 rd Most Recent Fault	Displays the third most recent fault.	-
U2-04	4 th Most Recent Fault	Displays the fourth most recent fault.	-
U2-05	Frequency Command at 1 st Most Recent Fault	Displays the frequency command at the first most recent fault.	-
U2-06	Output Frequency at 1 st Most Recent Fault	Displays the output frequency at the first most recent fault.	-
U2-07	Output Current at 1 st Most Recent Fault	Displays the output current at the first most recent fault.	0.01A
U2-08	Motor Speed at 1 st Most Recent Fault	Displays the motor speed at the first most recent fault.	0.1rpm
U2-09	Output Voltage command at 1 st Most Recent Fault	Displays the output voltage command at the first most recent fault.	0.1V
U2-10	Main Circuit DC Voltage at 1 st Most Recent Fault	Displays the main circuit DC voltage at the first most recent fault.	0.1V
U2-13	Input Terminal Status at 1 st Most Recent Fault	Displays the input terminal status at the first most recent fault. (Same status display as U1-09)	-
U2-14	Output Terminal Status at 1 st Most	Displays the output terminal status at the first most recent fault. (Same status display as U1-10)	-

Parameter	Name	Description	Unit
	Recent Fault		
U2-15	Operation Status at 1 st Most Recent Fault	Displays the operation status at the first most recent fault. (Same status display as U1-11)	-
U2-19	Frequency command at 2 nd Most Recent Fault	Displays the frequency command at the second most recent fault.	
U2-20	Output Frequency at 2 nd Most Recent Fault	Displays the output frequency at the second most recent fault.	-
U2-21	Output Current at 2 nd Most Recent Fault 2 nd	Displays the output current at the second most recent fault.	0.01A
U2-22	Motor Speed at 2 nd Most Recent Fault	Displays the motor speed at the second most recent fault.	-
U2-23	Output Voltage command at 2 nd Most Recent Fault	Displays the output voltage command at the second most recent fault.	0.1V
U2-24	Main Circuit DC Voltage at 2 nd Most Recent Fault	Displays the main circuit DC voltage at the second most recent fault.	0.1V
U2-27	Input Terminal Status at 2 nd Most Recent Fault	Displays the input terminal status at the second most recent fault. (Same status display as U1-09)	-
U2-28	Output Terminal Status at 2 nd Most Recent Fault	Displays the output terminal status at the second most recent fault. (Same status display as U1-10)	-
U2-29	Operation Status at 2 nd Most Recent Fault	Displays the operation status at the second most recent fault. (Same status display as U1-11)	-
U2-33	Current Alarm	Displays the current alarm.	-
U2-34	1 st Most Recent Alarm	Displays the first most recent alarm.	-
U2-35	2 nd Most Recent Alarm	Displays the second most recent alarm.	-
U2-36	3 rd Most Recent Alarm	Displays the third most recent alarm.	-
U2-37	4 th Most Recent Alarm	Displays the fourth most recent alarm.	-
U3: Maintenance Monitors			
U3-00	Cumulative Drive	Displays the cumulative operation time for the drive. The	1h

Parameter	Name	Description	Unit
	Operation Time	initial value is determined by o4-00. Keeping track of time from run or power up is determined by o4-01. The maximum number displayed is 9999, after which the value will be counted from 0.	
U3-10	Peak Hold Current	Displays the peak current value during operation	0.01A
U3-13	Frequency Command Source Selection	Displays the source for the frequency command as XY-nn. X: Command Used 1: Command 1 2: Command 2 Y-nn: Frequency Command Source 0-01: Keypad 1-01: Analog input (Terminal AI 1) 1-02: Analog input (Terminal AI 2) 2-02 to 2-16: Multi-step speed command 2-17: Jog frequency command 3-01: PID frequency command 4-01: Terminal UP/ DOWN 5-01: Modbus communication 6-01: Pulse train command	-
U3-14	Run Command Source Selection	Displays the source for the frequency command as XY-nn. XY-nn: 00-00: Local X: Command Used 1: Command 1 2: Command 2 Y-nn: Command Source 0-00: Keypad 1-00: Control circuit terminal (sequence control input) Analog input (Terminal AI 0: Keypad 1: Control Circuit Terminal (Sequence Control Input) 3: Modbus communication 4: Communication option card 7: LiteOn Studio PC software nn: Command Limit Status 00: No limit status 01: Run command was left on when stopped in programming mode 02: Run command was left on when switching from Local to Remote mode 03: Waiting for the charge to bypass MC after power up (Uv1 or Uv blinks after 10 s) 04: Waiting for the time of "Run command disabled" to	-

Parameter	Name	Description	Unit
		end 05: Fast Stop (multi-function terminal input or keypad) 06: b1-10 (Run command at power up) 07: During baseblock when coast to stop with timer 08: Frequency command is less than d1-08 (Minimum Output Frequency) during baseblock. 09: Waiting for ENTER command.	
U3-17	Drive Overload Estimate (oL2)	Displays the value of the drive overload detection accumulator. An oL2 will be triggered when reaching 100%.	1%
U4: PID Monitors			
U4-00	PID Feedback	Displays the PID feedback value as a percentage of the maximum output frequency.	0.01%
U4-01	PID Input	Displays the PID input value as a percentage of the maximum output frequency.	0.01%
U4-02	PID Output	Displays the PID output value as a percentage of the maximum output frequency.	0.01%
U4-03	PID Target	Displays the PID target value as a percentage of the maximum output frequency.	0.01%
U4-08	PID Output 2	Displays PID control output(100% is the max. frequency)	0.01%

Chapter 7 | Options

The following peripheral device options can be installed to improve the drive performance. Contact the local distributor to purchase the options if needed.

7.1 AC Reactor Option

7.1.1 Installing an AC Reactor

The non-linear components such as rectifiers and SCRs on the drive input side will cause high harmonic input current which interrupts the power supply and affects the power factor. To suppress the surges in current and improve the power factor, install an AC reactor on the drive input side in the following situations.

- To suppress harmonic current or improve the power factor of the power supply
- To suppress voltage surges on the input power when using a phase advancing capacitor switch so as to protect the connected devices.
- A large capacity power transformer (600kVA and above) is connected to the drive.

Note: Always install an AC reactor when connecting a SCR such as a DC drive to the same power supply regardless of the power supply conditions.

7.1.2 AC Reactor Wiring Example

Note: Do not connect the AC reactor to the drive output side (secondary side).

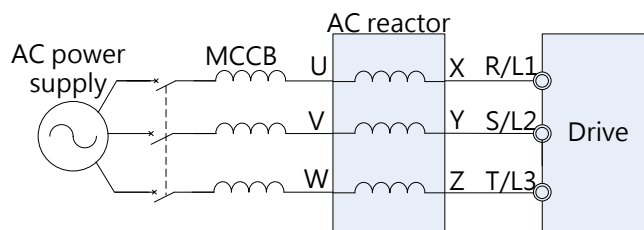

460V, 50/60Hz, Three phase

kW	HP	Reactor Rated Current	Max. Continuous Current	Inductance (mh) 3 to 5% Impedance	
				3% Impedance	5% Impedance
0.4	0.5	2	3	20	32
0.75	1	4	6	9	12
1.5	2	4	6	6.5	9
2.2	3	8	12	5	7.5
3.7	5	8	12	3	5

7.2 Installing Input Fuses

Installing fuses on the drive input side is recommended to prevent internal short circuit. Select the suitable fuses below or the branch circuit protection in compliance with local electrician regulations.

200V class single phase:

220V Model	Input Current I (A)	Line Fuse	
		I (A)	Bussmann P/N
0.2kW (0.25 HP)	3.6	6	FRS-R-6
0.4kW (0.5 HP)	7.4	10	FRS-R-10
0.75kW (1 HP)	13.5	20	FRS-R-20
1.5kW (2 HP)	24	30	FRS-R-30
2.2kW (3 HP)	33	40	FRS-R-40

200V class three phase

220V Model	Input Current I (A)	Line Fuse	
		I (A)	Bussmann P/N
0.2kW (0.25 HP)	2.2	5	FRS-R-5
0.4kW (0.5 HP)	3.7	5	FRS-R-5
0.75kW (1 HP)	6.6	10	FRS-R-10
1.5kW (2 HP)	10.5	15	FRS-R-15
2.2kW (3 HP)	14.8	20	FRS-R-20
3.7kW (5 HP)	21.5	30	FRS-R-30

400V class three phase

460V Model	Input Current I (A)	Line Fuse	
		I (A)	Bussmann P/N
0.4kW (0.5 HP)	2.7	10	FRS-R-10
0.75kW (1 HP)	4.4	10	FRS-R-10
1.5kW (2 HP)	6.7	10	FRS-R-10
2.2kW (3 HP)	9.3	15	FRS-R-15
3.7kW (5 HP)	12.9	20	FRS-R-20

Chapter 8 | Troubleshooting

8.1 Alarm and Fault Displays

Table 8.1 Alarm and Fault Displays, Causes, and Possible Solutions

Keypad Display	Fault Name	Cause	Possible Solution
EF0	Retain		
EF1 to EF6	External Fault (Input Terminal S1 to S6)	<ol style="list-style-type: none"> 1. An external device tripped an alarm 2. Incorrect wiring 3. Multi-function input wiring is not correct 	<ol style="list-style-type: none"> 1. Remove the cause of the external fault then reset the multi-function input. 2. Confirm if the signal lines is properly connected to the terminals assigned for external fault detection (E1-□□= 23 to 38) 3. Confirm if E1-□□=23 to 38 is set to the unused terminals.
FbH	<p>PID Feedback High</p> <p>PID feedback input is greater than the detection level set to b5-22 for longer than the detection time set to b5-23</p>	<ol style="list-style-type: none"> 1. b5-22 and b5-23 inappropriate setting 2. PID feedback wiring incorrect 3. Feedback sensor malfunction 4. Feedback input circuit malfunction 	<ol style="list-style-type: none"> 1. Confirm b5-22 and b5-23 settings 2. Correct the wiring 3. Replace the sensor if it is damaged 4. Replace the PCB or drive. Contact the local distributor.
FbL	<p>PID Feedback Low</p> <p>When the PID feedback detection is enabled in b5-11, a FbL will be triggered while the PID feedback falls below the level set to b5-12 for longer than the time set to b5-13.</p>	<ol style="list-style-type: none"> 1. Inappropriate setting in b5-12 and b5-13 2. Incorrect PID feedback wiring 3. Feedback sensor malfunction 4. Incorrect feedback input circuit 	<ol style="list-style-type: none"> 1. Correct b5-12 and b5-13 settings 2. Correct the wiring 3. Replace the sensor if it is damaged 4. Contact the local distributor to replace the board or the drive.
oH	Heatsink Overheat	<ol style="list-style-type: none"> 1. Ambient temperature is too high 	<ol style="list-style-type: none"> 1. Check the temperature surrounding the drive

Keypad Display	Fault Name	Cause	Possible Solution
	Heatsink temperature over 95°C	2. Internal cooling fan stopped operating 3. Bad air flow due to insufficient room.	a. Improve the air flow inside the enclosure panel b. Install an air conditioner or fan to cool the environment c. Remove any possible source of heat 2. Measure the output current a. Reduce the load b. Lower setting in C6-00 (Carrier Frequency Option) 3. Replace the cooling fan
oH1	Motor Overheat The temperature signal from motor temperature sensor via the multi-function analog input (E3-01=20) exceeded the overheat detection level of the drive.	1. Fault on the machinery (e.g., machinery is locked up) 2. Motor overheat	1. Check the machinery status 2. Check the load, acceleration / deceleration time and cycle time a. Reduce the load. b. Increase the C1-00 to C1-07 (Acc./Dec. Time) settings c. Adjust d1-02 to d1-11 (V/F Characteristics)
ot1	Overtorque Detection 1 The current has exceeded the torque level set to P6-01 for longer than the time set to P6-02	1. Incorrect parameter settings 2. Malfunction on machinery	1. Reset P6-01 and P6-02 2. Check machinery and load status
ov	Overvoltage Voltage in the DC bus exceeded the overvoltage detection level 1. 200 V class: 410 V 2. 400 V class: 820 V (740 V when d1-01 < 400)	1. Drive input power has surge voltage entering 2. Machinery output short circuit 3. Ground fault in the output circuit causes the DC bus capacitor to overcharge 4. Electrical signal interference causes drive malfunction	1. Install a DC link choke Voltage surge can result from a thyristor convertor and phase advancing capacitor using the same input power supply 2. Check the motor power cable, relay terminals and motor terminal box 3. Correct grounding shorts and reapply power 4. Check the solutions for interference suppression »Check the control circuit lines,

Keypad Display	Fault Name	Cause	Possible Solution
			<p>main circuit lines and grounding wiring.</p> <p>»If the MC is the source of interference, connect a suppressor to it.</p> <p>5. Reconnect the cable</p> <p>6. Correct the wiring</p>
Uv	<p>Undervoltage</p> <p>1.Voltage in the DC bus fell below the undervoltage detection level (P2-03)</p> <p>2.200 V class: 190 V</p> <p>3.400 V class: 380 V (350 V when d1-01 < 400)</p>	<p>1. Input power phase loss</p> <p>2. Loose wiring terminals of drive input power</p> <p>3. Problem with the voltage from the drive input power</p> <p>4. The drive main circuit capacitors are weakened.</p> <p>5. The contactor or relay on the soft-charge bypass circuit is damaged</p>	<p>1. Correct the drive input power wiring</p> <p>2. Tighten the terminals</p> <p>3. Check the voltage</p> <p>a. Adjust the voltage according to the drive input power specifications</p> <p>b. Check the main circuit magnetic contactor if there is no problem with the power supply</p> <p>4&5. Turn on and turn off the power to see if any problem occurs</p> <p>Replace either the entire drive or the control board if the problem continues to occur. Contact the local distributor for more information.</p>
Ut1	<p>Undertorque Detection 1</p> <p>The current has dropped below the torque detection level set to P6-01 for longer than the time set to P6-02</p>	<p>1. Incorrect parameter settings</p> <p>2.Malfunction on machinery side. Ex, the machinery is locked up</p>	<p>1. Reset P6-01 and P6-02</p> <p>2. Ensure there is no problem on the machinery side.</p>
bb	<p>Baseblock</p> <p>Drive output interrupted by an external baseblock signal</p>	<p>An external baseblock signal was input via one of the multi-function input terminals (S1 to S6)</p>	<p>Check baseblock signal input timing and external sequence</p>

Keypad Display	Fault Name	Cause	Possible Solution
oH2	Drive Overheat Warning Drive Overheat Warning input via a multi-function input terminal (S1 to S6) when E1-□□ = 40	An overheat warning in the drive was triggered by an external device	<ol style="list-style-type: none"> 1. Search the device which caused the overheat warning. Remove the cause of the problem. 2. Reset Drive Overheat Warning input at the assigned multi-function input terminal (S1 to S6)
HCA	Current Alarm Drive current exceeded the level of over current warning (150% of the rated current)	<ol style="list-style-type: none"> 1. The load is too heavy 2. Deceleration and acceleration times are too short 3. The drive is attempting to run a motor greater than the maximum allowable capacity, or a special-purpose motor is being used 4. The current level went up because of Speed Search while attempting to perform a fault restart or after a momentary power loss 	<ol style="list-style-type: none"> 1. Reduce the load or use a drive of higher rating 2. Calculate the torque required during acceleration and the inertia »Take the following steps if the torque level is not right for the load <ul style="list-style-type: none"> · Increase the settings for acceleration and deceleration time (C1-00 to C1-03) · Use a drive of higher rating 3. Check the motor capacity <ul style="list-style-type: none"> · Make sure the motor capacity is right for the drive rating. 4. During a momentary power loss or an attempt to reset a fault, the alarm is displayed. However, there is no need to take any action because the fault display will disappear shortly

8.2 Fault Detection

Table 8.2 Fault Displays, Causes, and Possible Solution

Keypad Display	Fault Name	Cause	Possible Solution
GF	Ground Fault	Output power cable is damaged	Check and replace output power cable
oVA, oVd, oVC	<p>Overvoltage (Acceleration, Deceleration and Constant Speed)</p> <p>The main circuit DC voltage exceeded the overvoltage detection level 200V class: 410V 400 V class: 820 V</p>	9	<ol style="list-style-type: none"> 1. Increase the deceleration time settings (C1-01 and C1-03) <ul style="list-style-type: none"> »Install a braking unit »Set P3-03 (Stall Prevention during Deceleration) to 1 (Enabled)(default is 1) 2. Confirm if overvoltage alarm oVA or oVC was triggered during sudden drive acceleration. <ul style="list-style-type: none"> »Increase the acceleration time »Use S-curve deceleration and acceleration times and increase the value set to C2-01 (S-curve at acceleration end) 3. Thyristor convertor and phase advancing capacitor using the same input power supply might cause a voltage surge 4. Check the motor power cable, relay terminals and motor terminal box <ul style="list-style-type: none"> » Correct grounding shorts and reapply power 5. Adjust parameter settings for Speed Search (group b3) <ul style="list-style-type: none"> »Proceed Auto-Tuning for line-to-line resistance 6. Check the voltage <ul style="list-style-type: none"> »Lower drive input power voltage within the range listed in the drive specifications 7. Check the wiring of the braking resistor and braking unit <ul style="list-style-type: none"> »Correct the wiring

Keypad Display	Fault Name	Cause	Possible Solution
			<p>8. Tighten the terminal or replace the damaged cable</p> <p>9. Correct the wiring</p> <p>10. Check the solutions for interference suppression</p>
oCA, oCd, oCC	Overcurrent (Acceleration, Deceleration and Constant Speed)	<p>1. The motor insulation is damaged or the motor is overheated</p> <p>2. Grounding problem caused by damaged motor cable</p> <p>3. The drive is damaged</p> <p>4. The load is too heavy</p> <p>5. Settings for acceleration or deceleration time is too short</p> <p>6. The drive is running a special purpose motor or a motor larger than the drive rated capacity</p> <p>7. A magnetic contactor (MC) on the output side of the drive has turned on or off</p> <p>8. V/F set incorrectly</p> <p>9. Excessive torque compensation</p> <p>10. Electrical signal</p>	<p>1. Check the insulation resistance</p> <p>2. Check the motor power cable</p> <p>3. Check the resistance between the cable and the terminal.</p> <p>4. Short circuit on drive output side or grounding causes register damage.</p> <p>5. > Measure the current flowing into the motor</p> <p>> Check the motor capacity</p> <p>6. Calculate the torque required during acceleration according to the load inertia and acceleration time. If the required torque is insufficient, check the motor capacity.</p> <p>7. Install a sequence controller to ensure the MC does not open or close when the drive is outputting voltage.</p> <p>8. Check the ratios between the frequency and voltage set by V/F.</p> <p>9. Adjust d1-02 to d1-11</p>

Keypad Display	Fault Name	Cause	Possible Solution
		<p>interference causes drive malfunction</p> <p>11. Run command was applied while motor was coasting</p> <p>12. Motor code is set incorrectly</p> <p>13. The motor does not match the drive control method</p> <p>14. The motor cable is too long</p>	<p>10. Check the amount of torque compensation</p> <p>11. > Find out possible solutions to suppress the electrical signal interference.</p> <p>> Input Speed Search command via multi-function input terminal</p> <p>12. Enable Speed Search via multi-function input terminal</p> <p>14. Check the control method (A1-02)</p> <p>15. Use a larger drive</p>
SC	IGBT Fault or Output Short Circuit	<p>1. Motor has been damaged due to the motor insulation weakened or overheat</p> <p>2. The cable is damaged</p> <p>3. Hardware fault</p> <p>4. The drive is damaged</p>	<p>1. Replace the motor or check the motor insulation resistance</p> <p>2. Repair any short circuits and check the motor power cable</p>
EFO	Retain		
EF1 to EF6	External Fault (Input Terminal S1 to S6)	<p>1. An external device tripped an alarm</p> <p>2. Incorrect wiring</p> <p>3. Multi-function input wiring is not correct</p>	<p>1. Remove the cause of the external fault then reset the multi-function input.</p> <p>2. Confirm if the signal lines is properly connected to the terminals assigned for external fault detection (E1-□□ = 23 to 38)</p> <p>3. Confirm if E1-□□ = 23 to 38 is set to the unused terminals.</p>
oH	Heatsink Overheat Heatsink temperature over 95 °C	<p>1. Ambient temperature is too high</p> <p>2. Internal cooling fan stopped operating</p> <p>3. Bad air flow due to insufficient room.</p>	<p>1. Check the temperature surrounding the drive</p> <p>a. Improve the air flow inside the enclosure panel</p> <p>b. Install an air conditioner or fan to cool the environment</p> <p>c. Remove any possible source of heat</p> <p>2. Measure the output current</p> <p>a. Reduce the load</p> <p>b. Lower setting in C6-00</p>

Keypad Display	Fault Name	Cause	Possible Solution
			(Carrier Frequency Option) 3.Replace the cooling fan
oH1	Motor Overheat 1 The temperature signal from motor temperature sensor via analog input terminal A1 (E3-01=20) exceeded the overheat detection level of the drive.	1. Incorrect motor temperature input (terminal MT) wiring 2. Fault on the machinery (e.g., machinery is locked up) 3. Motor overheat	1. Check the load, acceleration / deceleration time and cycle time a. Reduce the load b. Increase C1-00 to C1-03 (Acc./Dec. Time) settings 2. Adjust d1-02 to d1-09 (V/F Characteristics) Note: If the d1-02 and d1-09 are set too low, the tolerance at low speed will be reduced. 3.a. Check the setting for motor rated current. Set d1-00 as per the data written on the motor plate. b. Check if the motor cooling is working properly.
oL1	Motor Overload	1. The load is too heavy 2. The acceleration and deceleration times are too short 3. The motor is driven below the rated speed with a high load 4. Incorrect setting in P1-00 (Motor Protection Function Selection) when running a special motor 5. The voltage determined by the V/F is too high 6. d2-00 (Motor Rated Current) setting incorrect 7. The base frequency is set too low 8. Use one drive to run multiple motors 9. The electrical thermal protection characteristics do not match the motor overload characteristics.	1. Check loading capacity » Reduce the load 2. Confirm acceleration and deceleration times »Increase C1-00 to C1-03 parameter settings 3. »Reduce the load » Increase the speed » Either increase the motor capacity or use a special-purpose motor if the motor needs to operate at low speeds 4. Set P1-00 to 2. 5. Adjust d1-02 to d1-09 settings (V/F Characteristics) Note: If d1-02 to d1-09 settings are too low, load tolerance at low speeds will be reduced 6.Confirm the motor rated current » Set d2-00 (Motor Rated Current) according to the motor nameplate

Keypad Display	Fault Name	Cause	Possible Solution
		<p>10. The electrical thermal relay operates at the wrong level</p> <p>11. Motor overheated by overexcitation operations</p> <p>12. Speed Search related parameters are set incorrectly</p> <p>13. Power supply phase loss causes output current oscillation.</p>	<p>7. Confirm the rated frequency showed on the motor nameplate »Set d1-04 (Base Frequency) according to the motor nameplate</p> <p>8. Set P1-00 (Motor Protection Function Selection) to 0 (Disabled) and install a thermal relay to each motor</p> <p>9. Confirm characteristics of the motor »Set P1-00 (Motor Protection Function Selection) correctly »Install an external thermal relay</p> <p>10. Set the the motor rated current according to the motor plate.</p> <p>11. Adjust parameters related to Speed Search »Adjust the b3-01 (Speed Search Operation Current) setting</p> <p>12. Check the power supply for phase loss</p>
oL2	Drive Overload	<p>1. The load is too heavy</p> <p>2. The acceleration and deceleration times are too short</p> <p>3. The voltage determined by the V/F is too high</p> <p>4. The drive capacity is too small</p> <p>5. The motor is driven below the rated speed with a high load</p> <p>6. Torque compensation is too high</p> <p>7. Speed Search related parameters are set incorrectly</p> <p>8. Power supply phase loss causes output current</p>	<p>1. Check loading capacity » Reduce the load</p> <p>2. Confirm acceleration and deceleration times »Increase C1-00 to C1-03 parameter settings</p> <p>3. Adjust d1-02 to d1-09 settings (V/F Characteristics) Note: If d1-02 to d1-09 settings are too low, load tolerance at low speeds will be reduced</p> <p>4. Use a larger drive</p> <p>5. »Reduce the load at low speed » Use a larger drive » Set a lower value to C6-00 (Carrier Frequency)</p> <p>6. Check the torque compensation</p>

Keypad Display	Fault Name	Cause	Possible Solution
		oscillation	» Set a lower value to C3-00 (Torque Compensation Gain) until the current is decreased and the motor does not stall. 7. Adjust parameters related to Speed Search » Adjust b3-03 8. Check the power supply for phase loss
ot1	Overtorque Detection 1 The current has exceeded the torque level set to P6-01 for longer than the time set to P6-02	1. Incorrect parameter settings 2. Malfunction on the machinery side	1. Reset P6-01 and P6-02 2. Check machinery and load status
Ut1	Undertorque Detection 1 The current has dropped below the torque detection level set to P6-01 for longer than the time set to P6-02	1. Incorrect parameter settings 2. Malfunction on the machinery side	1. Reset P6-01 and P6-02 2. Ensure there is no problem on the machinery side.
Uv1	Undervoltage Detection 1 Voltage in the DC bus fell below the undervoltage detection level (P2-03) during run. · 200 V class: 190 V · 400 V class: 380 V	1. Input power phase loss 2. Loose wiring terminals of drive input power 3. Problem with the voltage from the drive input power 4. The drive main circuit capacitors are weakened. 5. The contactor or relay on the soft-charge bypass circuit is damaged	1. Correct the drive input power wiring 2. Tighten the terminals 3. Check the voltage a. Adjust the voltage according to the drive input power specifications b. Check the main circuit magnetic contactor if there is no problem with the power supply 4. Turn on and turn off the power to see if any problem occurs a. Replace either the entire drive or the control board if the problem continues to occur.

Keypad Display	Fault Name	Cause	Possible Solution
			Contact the local distributor for more information.
Uv2	Retain		
PF	Input Phase Loss Drive input power has a large imbalance of voltage between phases or has an open phase (Detected when P7-00=1)	1. Phase loss in the drive input power 2. Drive input power terminals has a loose wiring 3. Drive input power voltage has an excessive fluctuation 4. The main circuit capacitors are impaired	1. Check wiring for errors in the main circuit drive input power »Correct wiring 2. Make sure the terminals are tightened correctly »Apply the tightening torque as showed in the manual 3. Confirm the voltage from the drive input power »Apply possible solutions for drive input power stabilization 4. Check drive input power. If drive input power seems normal but the alarm continues to occur, replace either the entire drive or the control board. Contact the local distributor for more information.
LF1	Output Phase Loss Phase loss on the drive output side	1. The output cable is not connected 2. The motor winding is impaired 3. The output terminal is loose 4. The rated current of the motor being used is 5% less than the drive rated current 5. An output transistor is impaired 6. A single phase motor is activating	1. Check the errors for wiring then properly connect the output cable »Correct the wiring 2. Check the resistance which located between motor lines »If the winding is impaired, replace the motor 3. Use tightening torque which showed in the manual in order to fasten the terminal 4. Check motor capacities and the drive 5. The drive cannot run a single phase motor
FbH	PID Feedback High	1. Incorrect parameter settings 2. Incorrect PID feedback wiring	1. Reset b5-22 and b5-23 2. Correct the wiring 3. Check the sensor

Keypad Display	Fault Name	Cause	Possible Solution
		3. Feedback sensor malfunction	
FbL	PID Feedback Low	1. Incorrect parameter settings 2. Incorrect PID feedback wiring 3. Feedback sensor malfunction	1. Reset b5-12 and b5-13 2. Correct the wiring 3. Check the sensor
bUS	Retain		
CE	Modbus Communication Error	1. Incorrect wiring 2. Communication data error caused by noise	1. Correct the wiring »Check short circuits and disconnected cables, repair if necessary 2. Check possible solution to suppress the noise
CF	Retain		
Err	Retain		
JoGE	FJOG/ RJOG Input Error	A FJOG and RJOG Run commands are received at the same time	Check the Run command from the external source for Fjog/Rjog

8.3 Operation Errors

Table 8.3 Error Displays, Causes, and Possible Solutions

Keypad Display	Error Name	Cause	Possible Solution
oE02	Parameter Range Setting Error	Parameters are set outside of the possible setting range	<ol style="list-style-type: none"> 1. Set the parameters to the proper values 2. Reset the drive
oE03	Multi-Function Input Selection Error	<ol style="list-style-type: none"> 1. Either of Up command and Down command is not set (E1-□□= 10 or 11) 2. Either of Up command 2 and Down command 2 is not set (E1-□□=12 or 13) 	Properly assign both of the UP and Down commands to the multi-function input terminal.
oE04	3-Wire Sequence Control Error	Multi-Function input terminals S1 and S2 are assigned to E1-□□= 2 (3-Wire Sequence)	Do not assign multi-function input terminals S1 and S2 to E1-□□= 2 (3 – Wire Sequence)
oE05	Communication Error		
oE09	PID Control Selection Fault (When b5-00 (PID Control Setting)= 1 to 4)	<ol style="list-style-type: none"> 1. Contradictory settings <ul style="list-style-type: none"> · b5-14 (PID Sleep Start Level) is not set to 0.0 · b1-02 (Stopping Method Selection) is set to 2 (DC Braking to Stop) or 3 (Coast to Stop with Timer) 2. L2-01 (Frequency Command Lower Limit)≠0 when b5-00 = 1 or 2 (PID Control Enabled) 3. b5-10 (PID Output Reverse Selection) = 1 (Reverse Enabled) when b5-00 = 1 or 2 4. L2-01 ≠ 0 when b5-00 = 3 or 4 	<ol style="list-style-type: none"> 1. Correct the parameter setting. 2. Correct the parameter setting. 3. Correct the parameter setting. 4. Correct the parameter setting.
oE10	V/F Data Setting Error Incorrect d1-02,	V/F parameters setting incorrect	Correct the setting in d1-02, d1-04, d1-06, d1-08 and d1-09.

Keypad Display	Error Name	Cause	Possible Solution
	d1-04, d1-06, d1-08, d1-09 settings		
oE11	Carrier Frequency Setting Error	<p>1. Contradictory settings</p> <ul style="list-style-type: none"> · C6-03 (Carrier Frequency Proportional Gain) > 6 · C6-02 (Minimum Carrier Frequency) > C6-01 (Maximum Carrier Frequency) <p>Note: If $C6-03 \leq 6$, the drive operates at C6-01</p> <p>2. The upper and lower limit set in C6-00 to C6-03 are contradictory.</p>	Correct the parameter setting.

8.4 Auto-Tuning Fault Detection (Under Development)

Table 8.4 Auto-Tuning Codes, Causes, and Possible Solution

Keypad Display	Fault Name	Cause	Possible Solution
TF00	Auto-Tuning Stop	User presses STOP key during Auto-Tuning	Do not press STOP key during Auto-Tuning
TF01	Line-to Line Resistance Error	The line-to-line resistance in Auto-Tuning is negative or limited by the upper the lower limit	Check and correct motor wiring
TF02	Stationary Auto-Tuning Error	The voltage or current is too large during stationary Auto-Tuning	Make sure the data entered in t1-03 to t1-05 is the same as the information showed on the motor nameplate Check and correct motor wiring
TF03	Rotational Auto-Tuning Error	The voltage or current is too large during rotational Auto-Tuning	Make sure the data entered in t1-03 to t1-05 is the same as the information showed on the motor nameplate Check and correct motor wiring Perform Auto-Tuning after disconnect the motor from the machinery
TF07	Motor Data Error	t5-05 and t1-07 setting incorrect	Make sure the data entered to t1-05 and t1-07 is the same as the information showed on the motor nameplate. Reset the parameters.

Chapter 9 | Inspection & Maintenance

9.1 Safety



Electrical Shock

- Allow only qualified electrical engineers to install the drive. Failure to comply could cause electrical shocks to personnel or damage to the drive.
- Ensure the power supply is off when connecting. Failure to comply could cause electrical shocks.
- Shut off the power supply of all the equipment before inspection. Maintain the drive only when the CHARGE indicator light is off or 5 minutes after turning off power supply, so as to avoid charged capacitors causing physical injury.
- Do not perform wiring, remove option card or replace cooling fan during drive operation to prevent an electrical shock.
- Shut off the drive power supply and ensure no voltage is left before maintenance.
- Do not operate the drive with the drive enclosure removed. Failure to comply could cause electrical shocks.
- Properly wire the ground terminal of the motor side. Failure to comply could cause electrical shocks when touching the motor enclosure.
- Do not touch any live components to avoid electrical shocks.
- Do not touch the terminals. Avoid output cables contacting the drive enclosure.
- Do not inspect or maintain the drive when wearing loose clothing, jewelry or without eye protection. Failure to comply could cause electrical shocks or injury.

AC drives consist of electronics such as IC, resistors, capacitors, transistors fans and relays. As electronics components have limited life, characteristic changes or malfunction will occur after years of use under normal conditions. Regular inspections, components replacement are therefore necessary. Perform the regular inspection according to the check list in this chapter.

- More frequent inspection is needed in the following situations.
 - Poor storage conditions.
 - High ambient temperature
 - Frequent starts and stops
 - Excessive vibration or shock load
 - Fluctuations in the AC power supply or load
 - Dust, metal shavings, salt, sulfuric acid and chlorine atmospheres

Perform the first inspection one to two years after installation.

9.2 Periodic Inspection

Perform regular inspections according to the following check lists to ensure the optimum product performance and status.

9.2.1 Environment

Inspection Points	Corrective Action	Inspection Cycle		
		Daily	6 months	12 months
Ambient temperature, humidity, vibration, dust, harmful gases, oil mist, water.	Eliminate the source of contaminants or correct poor environment.	<input type="radio"/>		
Any foreign material or tool left around ?	Eliminate foreign material or tool.	<input type="radio"/>		

9.2.2 Voltage

Inspection Points	Corrective Action	Inspection Cycle		
		Daily	6 months	12 months
Is the DC bus and control circuit voltage normal ?	<ul style="list-style-type: none"> · Correct the voltage or power supply to within nameplate specifications. · Verify all main circuit phases. 	<input type="radio"/>		

9.2.3 Keypad Monitor

Inspection Points	Corrective Action	Inspection Cycle		
		Daily	6 months	12 months
Is the display clear to see ?	Clean the keypad monitor.	<input type="radio"/>		
Any character missing?	Contact the local Lite-On distributor.	<input type="radio"/>		

9.2.4 Enclosure

Inspection Points	Corrective Action	Inspection Cycle		
		Daily	6 months	12 months
Are the screws all tightened ?	Replace the damaged screws or terminals if tightening is not possible.		<input type="radio"/>	
Is the shape changed ?	<ul style="list-style-type: none"> · Replace the damaged components · Replace the entire drive if necessary. 		<input type="radio"/>	

Is the color changed by the heat ?	<ul style="list-style-type: none"> Replace the damaged components Replace the entire drive if necessary. 		<input type="radio"/>	
Any dust collection or stain?	<ul style="list-style-type: none"> Affix the terminal block cover Remove the dust with a vacuum cleaner Replace components if cleaning is not possible. 		<input type="radio"/>	

9.2.5 Main Circuit

Inspection Points	Corrective Action	Inspection Cycle		
		Daily	6 months	12 months
Are the screws all tightened ?	Replace the damaged screws or terminals if tightening is not possible.	<input type="radio"/>		
Any shape change, crack, damage or color change at the components or insulators because of heat ?	Replace the entire drive if the board is impossible to be repaired or replaced.		<input type="radio"/>	
Any dust collection or stain?	Remove the foreign material and dust.		<input type="radio"/>	

9.2.6 Main Circuit- Terminals & Cables

Inspection Points	Corrective Action	Inspection Cycle		
		Daily	6 months	12 months
Any shape or color change at the terminals or jumper because of heat ?	Repair or replace the damaged cables.		<input type="radio"/>	
Any damage or color change at the cables ?	Repair or replace the damaged cables.		<input type="radio"/>	

9.2.7 Main Circuit- Capacitors

Inspection Points	Corrective Action	Inspection Cycle		
		Daily	6 months	12 months
Any liquid leakage, color change, crack or swell?	Replace the entire drive if the component is impossible to be replaced.	<input type="radio"/>		
Has the cap come off or swollen?		<input type="radio"/>		
Measure the electrostatic capacity if necessary		<input type="radio"/>		

9.2.8 Main Circuit- Resistors

Inspection Points	Corrective Action	Inspection Cycle		
		Daily	6 months	12 months
Any odor or crack because of heat?	<ul style="list-style-type: none"> It is normal if the color changes slightly. Check the connection if the color changes. 	<input type="radio"/>		
Any disconnection?		<input type="radio"/>		
Any damage at the connection?		<input type="radio"/>		

9.2.9 Main Circuit- Magnetic Contactors & Relays

Inspection Points	Corrective Action	Inspection Cycle		
		Daily	6 months	12 months
Any noise during operation?	<ul style="list-style-type: none"> Check the circuit voltage respectively when the voltage exceeds or is within the tolerance. Replace the damaged MC, relay or board. 	<input type="radio"/>		
Any damage at the connection?		<input type="radio"/>		

9.2.10 Control Circuit- Control Boards & Connectors

Inspection Points	Corrective Action	Inspection Cycle		
		Daily	6 months	12 months
Are the screws and connectors all tightened ?	<ul style="list-style-type: none"> Fix the loose connections. Replace the board if an antistatic cloth or vacuum plunger cannot be used. Do not use any solvents to clean the board. Remove the dust with a vacuum cleaner. Replace the entire drive if the component is impossible to be cleaned or replaced. 		<input type="radio"/>	
Any odor or color change because of heat?			<input type="radio"/>	
Any crack, damage, shape change or rust?			<input type="radio"/>	
Any liquid leakage or swell at the capacitor?				<input type="radio"/>

9.2.11 Cooling- Fans

Inspection Points	Corrective Action	Inspection Cycle		
		Daily	6 months	12 months
Any abnormal noise or vibration?	Clean or replace the cooling fan.		○	
Are the screws all tightened ?			○	
Any color change because of heat?			○	

9.2.12 Cooling- Air Duct

Inspection Points	Corrective Action	Inspection Cycle		
		Daily	6 months	12 months
Any obstruction at the heatsink , air intake and exhaust openings?	Clean the obstruction and dust.		○	

9.3 Drive Cooling Fans

NOTICE: The cooling fan cannot operate properly when installed incorrectly and could damage the drive. Contact the local Lite-On distributor to order replacement colling fans when required. For drives with multiple cooling fans, replace all the cooling fans when performing maintenance to ensure maximum product performance life.

9.3.1 Cooling Fan Replacement



CAUTION

- Allow only qualified electrical engineers to install the drive. Failure to comply could cause electrical shocks to personnel or damage to the drive.
- Ensure the power supply is off when connecting. Failure to comply could cause electrical shocks.
- Shut off the power supply of all the equipment before inspection. Maintain the drive only when the CHARGE indicator light is off or 5 minutes after turning off power supply, so as to avoid charged capacitors causing physical injury.
- Do not perform wiring, remove option card or replace cooling fan during drive operation to prevent an electrical shock.
- Shut off the drive power supply and ensure no voltage is left before maintenance.
- Do not operate the drive with the drive enclosure removed. Failure to comply could cause electrical shocks.
- Properly wire the ground terminal of the motor side. Failure to comply could cause electrical

shocks when touching the motor enclosure.

- Do not touch any live components to avoid electrical shocks.
- Do not touch the terminals. Avoid output cables contacting the drive enclosure.
- Do not inspect or maintain the drive when wearing loose clothing, jewelry or without eye protection. Failure to comply could cause electrical shocks or injury.
- Do not touch the drive heatsink which could be very hot during operation.
- Do not replace the cooling fan until 15 minutes after shutting off the drive power and making sure the heatsink is cooled down.
- The cooling fan cannot operate properly when installed incorrectly and could damage the drive. Follow the instructions when replacing cooling fans. For drives with multiple cooling fans, replace all the cooling fans when performing maintenance to ensure maximum product performance life.

9.3.2 Removing Cooling Fan

1 to 3HP

1. Depress the right and left sides of the cooling fan cover tabs and pull outward.

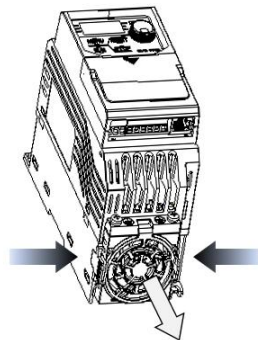

2. When the fan is pulled outward, disconnect the power cable.

Chapter 10 | Drive Derating

By derating the drive capacity, the drive can run at above the rated temperature, altitude and default carrier frequency. For example, a drive with 20 A rated current can be derated to 16A current so as to run with higher temperature tolerance.

Change the carrier frequency to derate the drive.

10.1 Temperature Derating

When the ambient temperature exceeds the tolerance specified in the product specifications, the drive output current must be derated to ensure the performance life. Meanwhile, set P7-12 (Installation Method Selection) according to the installation conditions so as to ensure reliable drive overload protection.

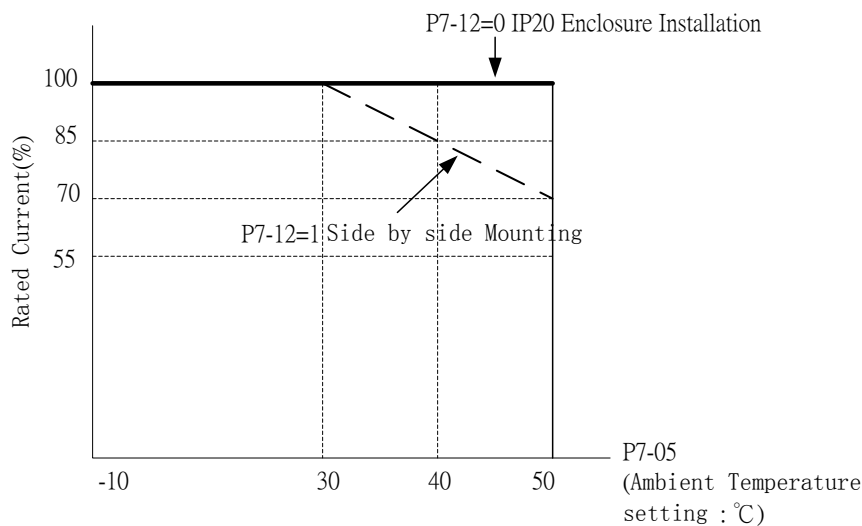

10.2 Altitude Derating

- The most appropriate altitude to install the drive is below 1000m.
- The drive rated voltage and the rated output current must be derated for 1% per 100 m for drive installations from 1000 m to 3000 m altitude.
- The drive cannot be installed above 3000 m altitude.

Chapter 11 | Communications

11.1 Modbus Communication Specifications

Item	Specifications
Interface	RS-485
Communications Cycle	Asynchronous
Communication Parameters	Communication speeds
	Data length
	Select even, odd or none
	Stop bit
Protocol	Modbus
Max number of Slaves	31 AC drives

11.2 Connecting to Controller/PLC/HMI

11.2.1 Communication Cable Connection

1. Connect the communications cable to the drive and the controller/PLC/HMI when the power is cut off. Use the drive terminal RJ45 for Modbus communication.

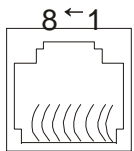

RS-485

- Pin 1:15v
- Pin 2:5v
- Pin 3,6:SGND
- Pin 4:SG-
- Pin 5:SG+
- Pin 7, 8:Reserved

Note: To prevent the interference, separate the communications cables from the main circuit cables, power cable and other wiring. Always use shielded cables for the communications cables, and shielded clamps.

2. Turn the power on.
3. Set the parameters needed for the communication(E6 - 00 to E6 - 12) using the keypad.
4. Shut the power off and wait until the display goes out.
5. Turn the power on.
6. The communication between the drive and the controller/PLC/HMI is now ready.

11.3 Modbus Setup Parameters

This section explains the parameters needed for Modbus communication.

E6- 06 Drive Station Address

Sets the drive station address.

Note: Cycle the drive power to activate the setting..

E6-06	Drive Station Address	Sets the drive station address.	Default: 1 Range: 1 to 31
-------	-----------------------	---------------------------------	------------------------------

Note: (1)When set to 0, the drive will not respond to the Modbus communication.

(2)The drive station address can be set in order or not, but can not be the same address.

E6- 07 Communication Speed Selection

Selects the speed for the Modbus communication.

Note: Cycle the drive power to activate the setting..

E6-07	RS-485 Communication Baud Rate Setting	Sets the baud rate for terminals SG(+) and SG(-) of RS-485 communication. 0: 1200 bps (bit/sec) 1: 2400 bps 2: 4800 bps 3: 9600 bps 4: 19200 bps 5: 38400 bps	Default: 3 Range: 0 to 5
-------	--	---	-----------------------------

E6- 08 RS-485 Communication Parity Selection

Sets the Modbus communication type.

E6-08	RS-485 Communication Parity Selection	Selects the communication parity for terminals SG(+) and SG(-) of RS-485 communication. 0: 8, N, 2 (Modbus RTU) 1: 8, N, 1 (Modbus RTU) 2: 8, E, 1 (Modbus RTU) 3: 8, O, 1 (Modbus RTU)	Default: 1 Range: 0 to 3
-------	---------------------------------------	---	-----------------------------

E6- 09 Communication Error Detection Time

Determines the detection time to trigger the communication error.

E6-09	Communication Error Detection Time	Determines the detection time to trigger the communication error. (This function is disabled when set to 0)	Default: 0.0 s Range: 0.0 to 10.0 s
-------	------------------------------------	---	--

If the drive does not receive any response via pulse train communication within the time set in

E6-09, the fault will be triggered.

E6- 10 Transmit Wait Time

Sets the wait time between sending and receiving data.

E6-10	Transmit Wait Time	Sets the wait time between sending and receiving data.	Default: 5ms Range: 5 to 65 ms
-------	--------------------	--	-----------------------------------

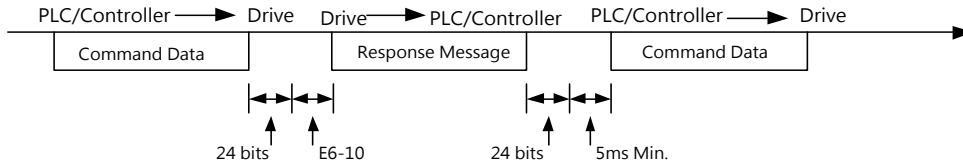

11.4 Drive Operations by Modbus

The drive operations by Modbus communication are determined by the drive parameter settings. This section explains the provided functions and the related parameters.

11.4.1 Actions by Modbus

The following actions can be performed by a PLC regardless of the parameter settings except for E6 parameters.

- Monitor drive operation from a PLC.
- View and change parameter settings.
- Reset faults.
- Assign multi-function inputs.

11.4.2 Drive Control by Modbus

Select Modbus communication according to the following table to run/stop the motor and give frequency commands.

b1-00	Frequency Command Selection 1	0: Keypad 1: Control Circuit Terminal (Analog Input) 2: Terminal Up/Down 3: Modbus Communication	Default: 1 Min.: 0 Max.: 3
b1-01	Run Command Selection 1	0: Keypad 1: Control Circuit Terminal (Sequence Control Input) 2: Modbus Communication	Default: 1 Range: 0, 1, 2

11.5 Message Format

11.5.1 Message Content

In Modbus communications, the master gives commands to the slave, and the slave responds. The following table shows the configured message for both sending and receiving, and the length of data packets is determined by the command (function) content.

11.5.2 Message Configuration

RTU scheme:

START	Retain no signal input ≥ 10 ms
Address	Station address: 8-bit binary
Function	Function code: 8-bit binary
DATA (n-1)	Data Characters: $n \times 8$ -bit data, $n \leq 16$
.....	
DATA 0	
CRC CHK Low	CRC checksum: 16-bit, consists of 2 sets of 8-bit binary
CRC CHK High	
END	Retain no signal input ≥ 10 ms

11.5.3 Slave Station Address

Use code between 0 and FF (hex) to set the slave station address. If a message with slave station address 0 is sent (broadcast), the command from the master will be sent to all slaves. The slave do not responds to a broadcast message.

00H: To all drive (broadcast)

01H: To drive address 01

0FH: To drive address 15

10H: To drive address 16, so on and so forth up to 31(1FH).

11.5.4 Function Code

There are four types of function codes:

03H : Read Modbus registers

06H : Write a word to registers(Write to registers)

08H : Loopback test

10H : Write to multiple registers

11.5.5 Data

By combining the Modbus register address (test code in case of a loopback test) and the

register data, the drive configures consecutive data. The length of the data depends on the command details.

The Modbus register always consists of a data length of two bytes. Data written into the register must also consist of a length of two bytes. Register data read out from the drive will always have two bytes.

11.5.6 Error Check

The drive check data validity using CRC scheme.

11.5.7 Command Data

When the drive receives data, it checks for errors. To do so, the drive calculates the CRC and compares it to the CRC-16 value received in the message. The command will not be processed if these two values do not match.

Use the default value of FFFFH (i.e., all 16 bits equal 1) to calculate CRC-16 in Modbus. Calculate the CRC-16 checksum using the following steps:

- (1). The starting value of a 16-bit register value is FFFFH (all 16 bits equal 1).
- (2). Perform an exclusive OR of this value and the slave address. Then save the result in the register.
- (3). Right shift the result, put 0 to the left of the high-order byte and check the CRC register value.
- (4). If the value is 0, save the result from step (3) above in the CRC register. If the value is not 0, perform an exclusive OR of the result from step (3) and the value A001h(1010 0000 0000 0001). Then save the result in the CRC register.
- (5). Repeat step (3) and (4) until 8-bit operations are all performed.
- (6). Repeat step (2) to (5). Receive next 8-bit command data until all the command data are calculated. The result of the last shift is the CRC checksum. Send the low-order byte before the high-order byte when sending the CRC checksum. For an example of CRC checksum 1241hex, the high-order byte of CRC-16 must be set to 41hex, and the low-order byte must be set to 12hex.

□ CRC Calculation:

```
UWORD ch_sum ( UBYTE long , UBYTE *rxdbuff ) {  
    BYTE i = 0;  
    UWORD wkg = 0xFFFF;  
    while ( long-- ) {  
        wkg ^= rxdbuff++;  
        for ( i = 0 ; i < 8 ; i++ ) {
```

```

    if ( wkg & 0x0001 ) {
        wkg = ( wkg >> 1 ) ^ 0xa001;
    }
    else {
        wkg = wkg >> 1;
    }
}
}
return( wkg );
}

```

11.5.8 Response Message

Perform a CRC calculation on the response message according to the above description. The result of the calculation should match the CRC checksum of the response message.

11.6 Example of Reading / Responding Data

The following are examples of command and response data.

Example: For the drive address 01H, To read 2 consecutive register data for the drive address 01H, the message is "starting address 2422H.

RTU Scheme:

Command Message:		Respond Message:	
Address	01H	Address	01H
Function	03H	Function	03H
Starting data address	24H	Number of data (count by byte)	04H
	22H		Content of data address 2422H
Number of data (count by word)	00H	Content of data address 2423H	
	02H		00H
CRC CHK Low	6EH	CRC CHK Low	FEH
CRC CHK High	F1H	CRC CHK High	5CH

Function code 06H: Write one piece of data to register

Example: For the drive address 01H, 1(01H) will written to the drive internal parameter 0100H (b1-00).

RTU Scheme:

Command Message:		Respond Message:	
Address	01H	Address	01H
Function	06H	Function	06H
Data address	01H	Data address	01H
	00H		00H
Data content	00H	Data content	00H
	01H		01H
CRC CHK High	49H	CRC CHK High	49H
CRC CHK Low	F6H	CRC CHK Low	F6H

Command code: 10H, write consecutive data to register (Max. 20 pieces of consecutive data).
 For example, changing the drive (address 01H) multi-step speed setting L1-00=60.00 (0880H),
 L1-01=50.00 (8801H).

RTU Scheme:

Command Message:		Respond Message:	
ADR	01H	ADR	01H
CMD	10H	CMD	10H
Starting Address (Word)	08H	Starting Address (Word)	08H
	80H		80H
Data Quantity (Word)	00H	Register Written Quantity (Word)	00H
	02H		02H
Data Quantity (Byte)	04H		
First Storage Register	00H 3CH	CRC Check High	42H
Second Storage Register	00H 32H	CRC Check Low	40H
CRC Check High	DDH		
CRC Check Low	D6H		

An extra response during a communication error

When a error occurs during communication with the drive, the drive responds to the error code, set the highest-order byte (bit7) of command data to 1 (Function code AND 80H) and

respond to the upper control to inform upper control about the error. And the drive keypad displays CE-XX (XX is the error code) as the warning message. Refer to 11.8.1 Modbus Errors.

Example:

RTU Scheme:	
Address	01H
Function	86H
Exception code	02H
CRC CHK Low	C3H
CRC CHK High	A1H

11.7 Modbus Data

The following tables shows all data including command, monitor and broadcast.

■ Command Data (Read and write)

Register No.	Definitions	
2400H	Retain	
2401H	Operation Commands	
	Bit 0	Stop/Run (0:Stop, 1:Run)
	Bit 1	Forward/Reverse (0:Forward, 1:Reverse)
	Bit 2	External Fault EFO
	Bit 3	Fault Reset
	Bit 4	Retain
	Bit 5	Retain
	Bit 6	Retain
	Bit 7	Retain
	Bit 8	Multi-Function Terminal 1 (1: ON)
	Bit 9	Multi-Function Terminal 2 (1: ON)
	Bit 10	Multi-Function Terminal 3 (1: ON)
	Bit 11	Multi-Function Terminal 4 (1: ON)
	Bit 12	Multi-Function Terminal 5 (1: ON)
Bit 13	Multi-Function Terminal 6 (1: ON)	

Register No.	Definitions	
	Bit 14	Multi-Function Terminal 7 (1: ON)
	Bit 15	Multi-Function Terminal 8 (1: ON)
2402H	Frequency Command (0.01Hz Units)	

■ Monitor Data (Read Only)

Register No.	Definitions	
2420H	Retain	
2421H	Opeartion Status	
	Bit 0	1: During Run
	Bit 1	1: During reverse
	Bit 2	1: During Zero speed
	Bit 3	1: During fault
	Bit 4	1: During alarm detecton
	Bit 5	1: During speed agree
	Bit 6	1: During ready
	Bit 7	1: Frequency command provided from communication
	Bit 8	1: Run command provided from Remote communication
	Bit 9	Retain
Bit 11 to 15	Retain	
2422H	Frequency command (0.01Hz units)	
2423H	Output frequency (0.01Hz units)	
2424H	Output current (0.1A units)	
2425H	Output voltage (0.1V units)	
2426H	DC voltage (0.1V units)	
2427H	Alarm description	
2428H	Fault description	
2429H	Multi-Function Inputs and Outputs Status	
	Bit 0	1: Multi-Function Terminal 1 ON
	Bit 1	1: Multi-Function Terminal 2 ON
	Bit 2	1: Multi-Function Terminal 3 ON
	Bit 3	1: Multi-Function Terminal 4 ON
	Bit 4	1: Multi-Function Terminal 5 ON
Bit 5	1: Multi-Function Terminal 6 ON	

	Bit 8 to 10	Retain
	Bit 12	1: Relay 1 ON
	Bit 14	Retain
	Bit 15	Retain
242AH	AI1 input (0 equals 0V or 0mA, 1000 equals 10V or 20mA)	
242BH	communication	
242CH	Retain	
242DH	AO1 input (0 equals 0V, 1000 equals 10V)	
242EH	communication	

■ Alarm Data (2427H)

No.	Contents	No.	Contents	No.	Contents
0	No alarm	13	Retain	26	Ut1 (Undertorque Detection 1)
1	EF0 (Communication Fault)	14	Retain	27	Retain
2	EF1 (External Fault 1)	15	Retain	28	Retain
3	EF2 (External Fault 2)	16	Retain	29	Retain
4	EF3 (External Fault 3)	17	Retain	30	Retain
5	EF4 (External Fault 4)	18	FbH (PID Feedback High)	31	BB(Baseblock)
6	EF5 (External Fault 5)	19	FbL (PID Feedback Low)	32	OH2 (Heatsink Overheat warning)
7	EF6 (External Fault 6)	20	OH (Heatsink Overheat)	33	HCA(Current Alarm)
8	Retain	21	Retain	34	DNE (Drive Disable)
9	Retain	22	ot1 (Overtorque Detection 1)	35	Retain
10	Retain	23	Retain	36	CE (Modbus Communication Error)
11	Retain	24	Ov (Overvoltage)	37	Retain
12	Retain	25	Uv(Undervoltage)	38	Retain

■ Fault Data (2428H)

No.	Contents	No.	Contents	No.	Contents
0	No fault	31	Retain	62	Retain
1	GF (Ground Fault)	32	Retain	63	SER (速度搜寻异常)
2	oVA (Acceleration Overvoltage)	33	OH (Heatsink Overheat)	64	Retain
3	oVd (Deceleration Overvoltage)	34	Retain	65	CF01
4	oVC (Constant Speed Overvoltage)	35	Retain	66	CF02
5	oCA (Acceleration Overcurrent)	36	oL1 (Motor Overload)	67	CF03
6	oCd (Deceleration Overcurrent)	37	oL2 (Drive Overload)	68	CF04
7	oCC (Constant Speed Overcurrent)	38	Retain	69	CF05
8	EF	39	Retain	70	CF06
9	SC (IGBT Fault or Output Short Circuit)	40	Retain	71	CF07
10	Retain	41	Ut1 (Undertorque Detection 1)	72	Retain
11	Retain	42	Retain	73	JOGE (FJOG, RJOG Input Error)
12	Retain	43	Retain	74	Retain
13	Retain	44	Uv1(Undervoltage Detection 1)	75	Retain
14	Retain	45	Uv2 (Control Power Supply Voltage Fault)	76	Retain
15	Retain	46	PF (Input Phase Loss)	77	Retain
16	Retain	47	LF1(Output Phase Loss)	78	Retain
17	EF0 (Option Card External Fault)	48	Retain	79	Retain
18	EF1 (External Fault 1)	49	Retain	80	Retain
19	EF2 (External Fault 2)	50	Retain	81	TF00
20	EF3 (External Fault 3)	51	Retain	82	TF01
21	EF4 (External Fault 4)	52	Retain	83	TF02
22	EF5 (External Fault 5)	53	Retain	84	TF03

23	EF6 (External Fault 6)	54	FbH (PID Feedback High)	85	Retain
24	Retain	55	FbL (PID Feedback Low)	86	Retain
25	Retain	56	bUS (Option Communication Error)	87	Retain
26	Retain	57	CE (Modbus Communication Error)	88	TF07
27	Retain	58	CF (Control Fault)	89	Retain
28	Retain	59	Err (EEPROM Error)	90	Retain
29	Retain	60	Retain	91	Retain
30	Retain	61	Retain		

11.8 Communication Errors

11.8.1 Modbus Errors

The Modbus error codes are listed in the following table.

When an error occurs, remove the cause of the fault and restart communications. Each error code may have different definitions depending on the function code.

Error Code	Function Code	Description
1	3,6,8,10	Function code error
2	3	Read data is outside the setting range
	6	Write data is outside the setting range
	10	Write data is outside the setting range
3	3	Read data exceeds 125 pieces
	6	Write data is outside the setting range
	8	Read request value error including CRC check error
	10	Write data exceeds 123 pieces or byte count does not match the amount of write data.
4	3	Read register error
	6	Write register error
	8	Response pocket error
	10	Write register error

11.8.2 Slave Response

In the following situations, the slave will ignore the command message sent from the master and not respond to it.

- When a communications error (overrun, framing, parity, or CRC) is detected in the command message.
- The slave address in the command message do not match the slave address in the drive (Set the slave address for the drive using E6-06 in advance).
- The gap between two blocks of a message is greater than 24 bits.
- The command message length is incorrect.

Note: When the slave address in the command message is 00H, all slaves perform the write function, but do not send any response message to the master.

EVO6000UMEN1602V01

EVOLution Series

Copyright© 2014 LITEON Industrial Automation. All Rights Reserved

Group Headquarters : 22F, 392, Ruey Kuang Road, Neihu, Taipei City 114, Taiwan
IA Headquarters : 11F, 866-1, Chung-Zheng Rd., Chung Ho District, New Taipei City 235,
Factory : 7, Lane 3, San-Ho Rd., San-Shi Village, Dayuan Town, Taoyuan County 337, Taiwan
TEL : +886-2-2223-1189ext.8608
Email: IA-Hotline.Overseas@liteon.com



www.liteon-ia.com.cn